

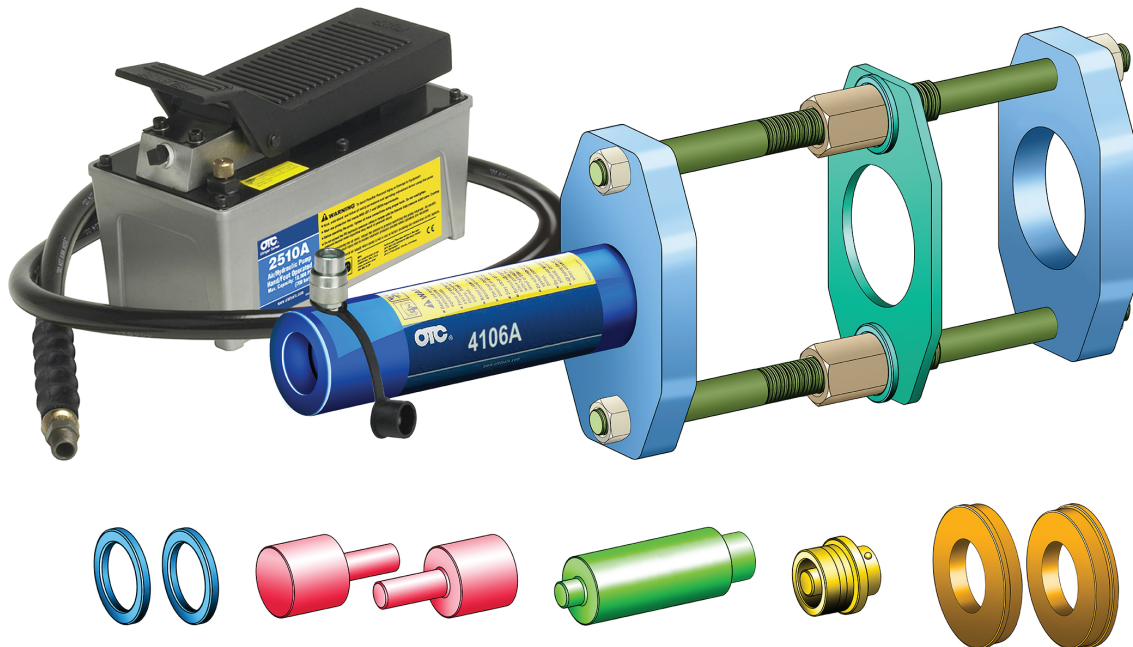

4255  
4261

# Airtek NXT Suspension Bushing Tool



**Application:** Hendrickson AIRTEK NXT  
(Rear bushing only)

## INSTRUCTIONS



© Bosch Automotive Service Solutions Inc.

[otctools.com](http://otctools.com)

**QUESTIONS?**  
☎ 800 533 6127

## Explanation of Safety Signal Words

The safety signal word designates the degree or level of hazard seriousness.



**DANGER:** Indicates an imminently hazardous situation which, if not avoided, will result in death or serious injury.



**WARNING:** Indicates a potentially hazardous situation which, if not avoided, could result in death or serious injury.



**CAUTION:** Indicates a potentially hazardous situation which, if not avoided, may result in minor or moderate injury.

**CAUTION:** Used without the safety alert symbol indicates a potentially hazardous situation which, if not avoided, may result in property damage.

# Safety Precautions

---



**WARNING:** To prevent personal injury and/ or property damage,



- Study, understand, and follow all safety precautions and operating instructions before using this Hendrickson Front Suspension Bushing Tool. If the operator cannot read instructions, operating instructions and safety precautions must be read and discussed in the operator's native language.

- Only qualified operators may install, operate, adjust, maintain, clean, repair, inspect, or transport this suspension bushing tool.



- Wear eye protection that meets ANSI Z87.1, CE EN166, AS/NZS 1337, and OSHA standards.
- Do not use this suspension bushing tool for anything other than its intended purpose.
- No alteration shall be made to this product.
- Inspect the condition of the suspension bushing tool before each use; do not use if damaged, altered, or in poor condition.
- Use only those repair parts called out in the parts list in this document. Items found in the parts list have been carefully tested and selected by OTC.

## Hose



- Before operating the pump, tighten all hose connections using the correct tools. Do not overtighten; connections need only be secure and leak-free. Overtightening can cause premature thread failure or high pressure fittings to split at pressures lower than their rated capacities.
- Should a hydraulic hose ever rupture, burst, or need to be disconnected, immediately shut OFF the pump, and open the control valve to release all pressure. NEVER grasp a leaking, pressurized hose with your hands; the force of escaping hydraulic fluid could cause serious injury.
- Do not subject the hose to any potential hazard such as fire, extreme cold or heat, sharp surfaces, or heavy impact. Do not allow the hose to kink, twist, curl, or bend so tightly that the fluid flow within the hose is blocked or reduced. Do not use the hose to move attached equipment. Periodically inspect the hose for wear, because any of these conditions can damage the hose and result in personal injury.
- Hose material and coupler seals must be compatible with the hydraulic fluid used. Hoses also must not come in contact with corrosive materials, such as creosote-impregnated objects and some paints. Consult the manufacturer before painting a hose. Never paint couplers. Hose deterioration due to corrosive material can result in personal injury.

## Pump

- Do not exceed the maximum capacity of the pump or tamper with the internal high pressure relief valve. Creating pressure beyond the rated capacity can result in personal injury.
- Completely retract the cylinder before opening the filler screw on the pump to add hydraulic fluid. An overfill can cause personal injury due to excess reservoir pressure created when cylinders are retracted.

## Cylinder



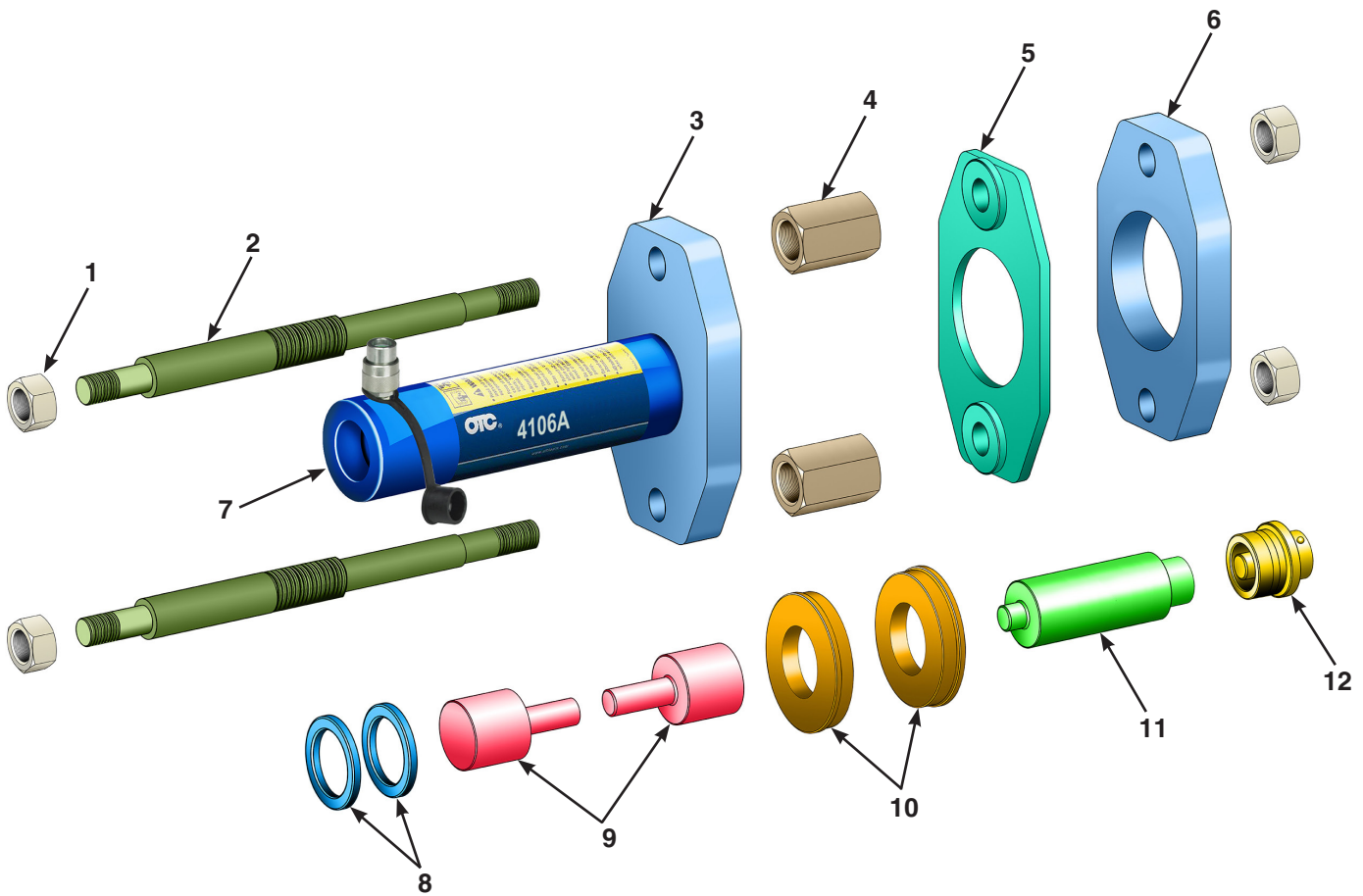

- Do not exceed the maximum capacity of the cylinder. Creating pressure beyond the rated capacity can result in personal injury.
- Adapters must be aligned and fully engaged so cylinder force is straight, avoiding an off-center load condition.

# Parts List

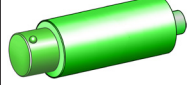
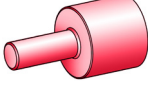

Item No.	Part No.	Qty.	Description
1	576924	1	Hex Nut Kit ( <i>contains four nuts</i> )
2	575170	2	Threaded Rod
3	575173	1	Cylinder Mounting Plate
4	575169	2	Clamping Nut
5	561682	1	Clamping Plate Assembly
6	575172	1	Head Plate
7	4106A	1	Hydraulic Cylinder ( <i>25 Ton</i> )
8	581731	2	Spacer
9	581678	2	Alignment Tool
10	581683	2	Bushing Support Adapter
11	581734	1	Extractor
12	581730	1	Cylinder Adapter
	575166	1	Warning Decal ( <i>not shown</i> )
	104031	1	Warranty / Authorized Service Center List ( <i>not shown</i> )
	36886	1	Hose Assembly ( <i>4261 only; not shown</i> )
	2510A	1	Air / Hydraulic Pump ( <i>4261 only; not shown</i> )
	9798	1	Hose Half Coupler ( <i>4261 only; not shown</i> )

# Rear Spring Eye Bushing Removal

	581731 Spacer	581734 Extractor	581678 Alignment Tool	581683 Small Bushings Support Adapter	581682 Clamping Plate Assembly	581730 Cylinder Adapter
						
<b>Remove</b>		✓	✓	✓	✓	
<b>Install</b>	✓(2 required)			✓	✓	✓

## Rear Spring Eye Bushing Removal

1. Insert the two *alignment tools* into the bushing as shown in Figure 1.
2. Place each *bushing support adapter* over an alignment tool.
3. Place the *head plate* over the bushing support.
4. Place the *clamping plate* over the other alignment tool. **Note: Plate must be positioned so the snap rings face the spring.**
5. Assemble the *clamping nuts* to the *threaded rods*.
6. Insert a threaded rod through the lower holes in the clamping plate and the head plate. Install a *hex nut* on the end of the threaded rod, fully seated and finger tight.
7. Insert a threaded rod through the upper holes in the clamping plate and the head plate. Install a hex nut on the end of the threaded rod, fully seated and finger tight.
8. Tighten the clamping nuts to the clamping plate 1/4 to 1/2 turn past hand tight. See Figure 2.

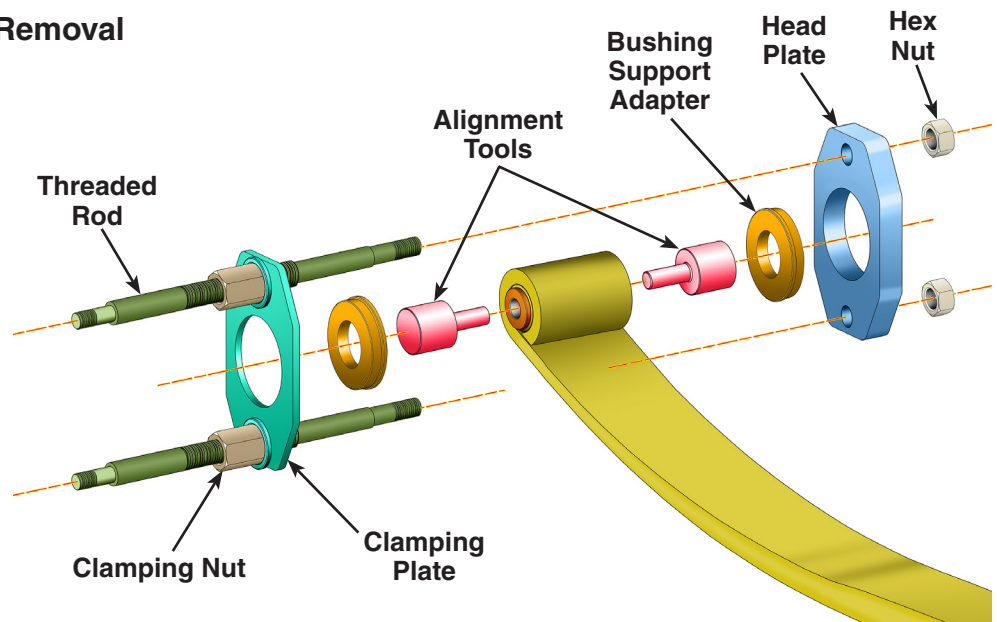

**Figure 1**

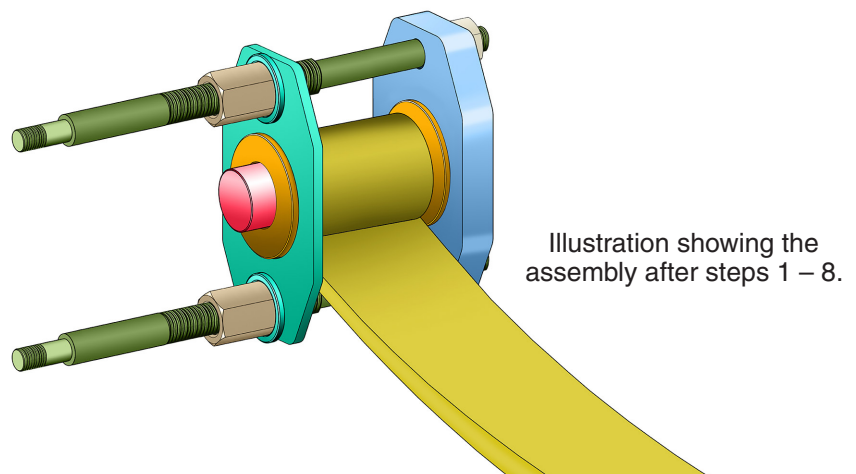
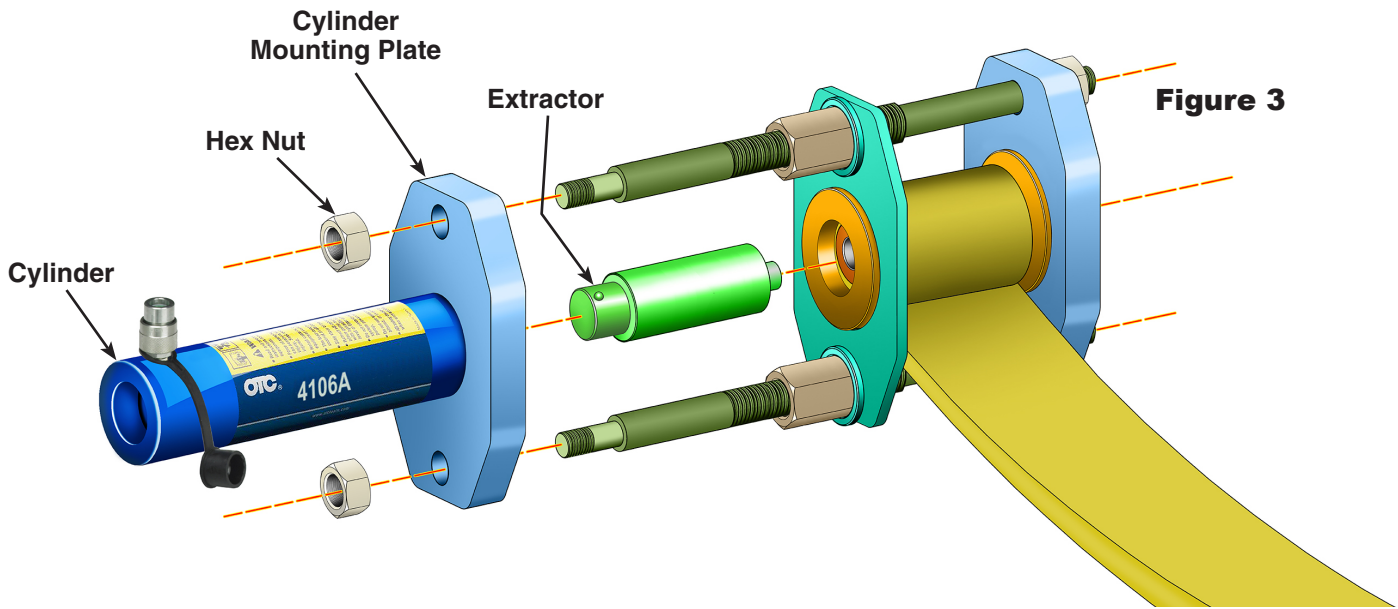

Illustration showing the assembly after steps 1 – 8.

**Figure 2**

# Rear Spring Eye Bushing Removal



## Rear Spring Eye Bushing Removal contd.

9. Thread the cylinder into the *cylinder mounting plate*. See Figure 3.

**⚠ WARNING: To prevent personal injury, the cylinder must be fully threaded into the cylinder mounting plate.**

10. Install the cylinder mounting plate onto the end of the threaded rods. Assemble the hex nuts on the threaded rods until they are fully seated and finger tight.

11. Carefully remove the two alignment tools.

12. Insert the extractor into the cylinder adapter.

13. Prepare the hydraulic pump for use by following the instructions provided with the pump regarding hookup, venting, priming, and operation.

**⚠ WARNING: To prevent personal injury, pump capacity must not exceed 10,000 psi.**

14. Connect the hydraulic hose from the hydraulic pump to the cylinder.

17. Verify all components are aligned. Slowly and carefully operate the pump to extend the cylinder piston rod. Guide the extractor until it contacts the bushing. Operate the pump until the bushing is driven out of the spring.

**⚠ WARNING: To prevent personal injury from possible breakage under pressure, do not stand in the vicinity of the tool while the spring eye bushing is being extracted. It is especially important to not stand in the direction of the hydraulic force.**



15. Retract the cylinder piston rod. Spring eye bushing removal is complete. *Note: Do not remove the tool assembly from the spring before installing the new bushing because the alignment would be lost.*

# Rear Spring Eye Bushing Installation

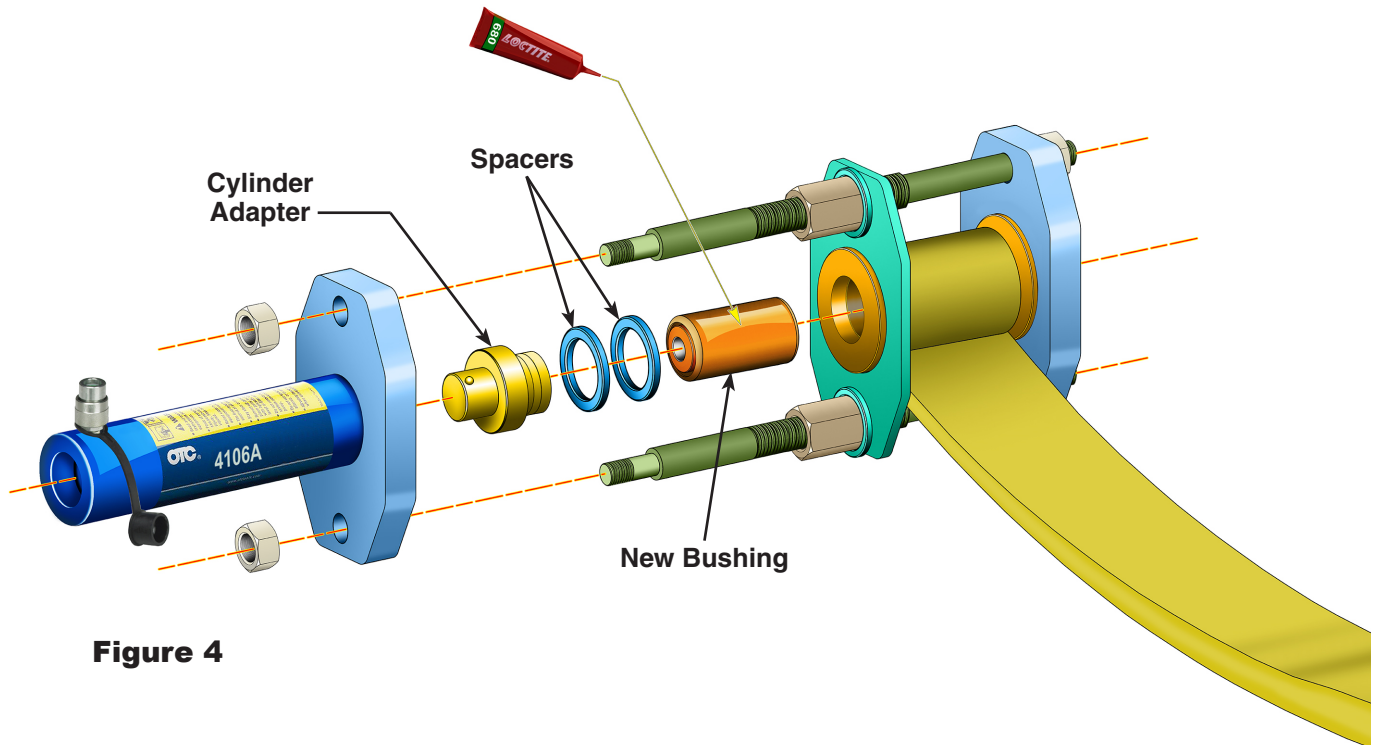

**Figure 4**

## Rear Spring Eye Bushing Installation

1. Remove residual adhesive from the inside diameter of the beam using Hendrickson-approved methods. The cylinder and cylinder mounting plate may be removed to allow easier access to the spring eye.  
*Note: Do not loosen the clamping nuts, or remove the head or clamping plate, before installing the new bushing because the alignment would be lost.*
2. Insert the cylinder adapter into the head of the cylinder as shown in Figure 4.
3. Place spacers over the cylinder adapter.
4. Clean the outer diameter of the new bushing and apply Loctite® 680 adhesive, being careful to apply the adhesive to metal only. Do not apply adhesive to the rubber part of the bushing.
5. Hold the bushing against the face of the bushing adapter.
6. Operate the pump to extend the cylinder piston rod. Guide the assembly until the bushing contacts the bore of the spring. Check the alignment of the spring eye bushing.

**⚠ WARNING: To prevent personal injury, pump capacity must not exceed 10,000 psi.**

7. Operate the pump to drive the bushing into the spring. When the spacer contacts the clamping plate, bushing installation is complete.



**⚠ WARNING: To prevent personal injury from possible breakage under pressure, do not stand in the vicinity of the tool while the spring eye bushing is being installed. It is especially important to not stand in the direction of the hydraulic force.**

8. Wipe away any residual Loctite® 680 adhesive from exposed faces of the bushing, spring, and tools.

# Tool Information

## Installing Bushings Without Using Spacers

The graduation marks on No. 581730 Cylinder Adapter match the thickness of No. 581731 Spacer(s). In the absence of spacers, the graduation marks may still be used to monitor bushing depth during installation.

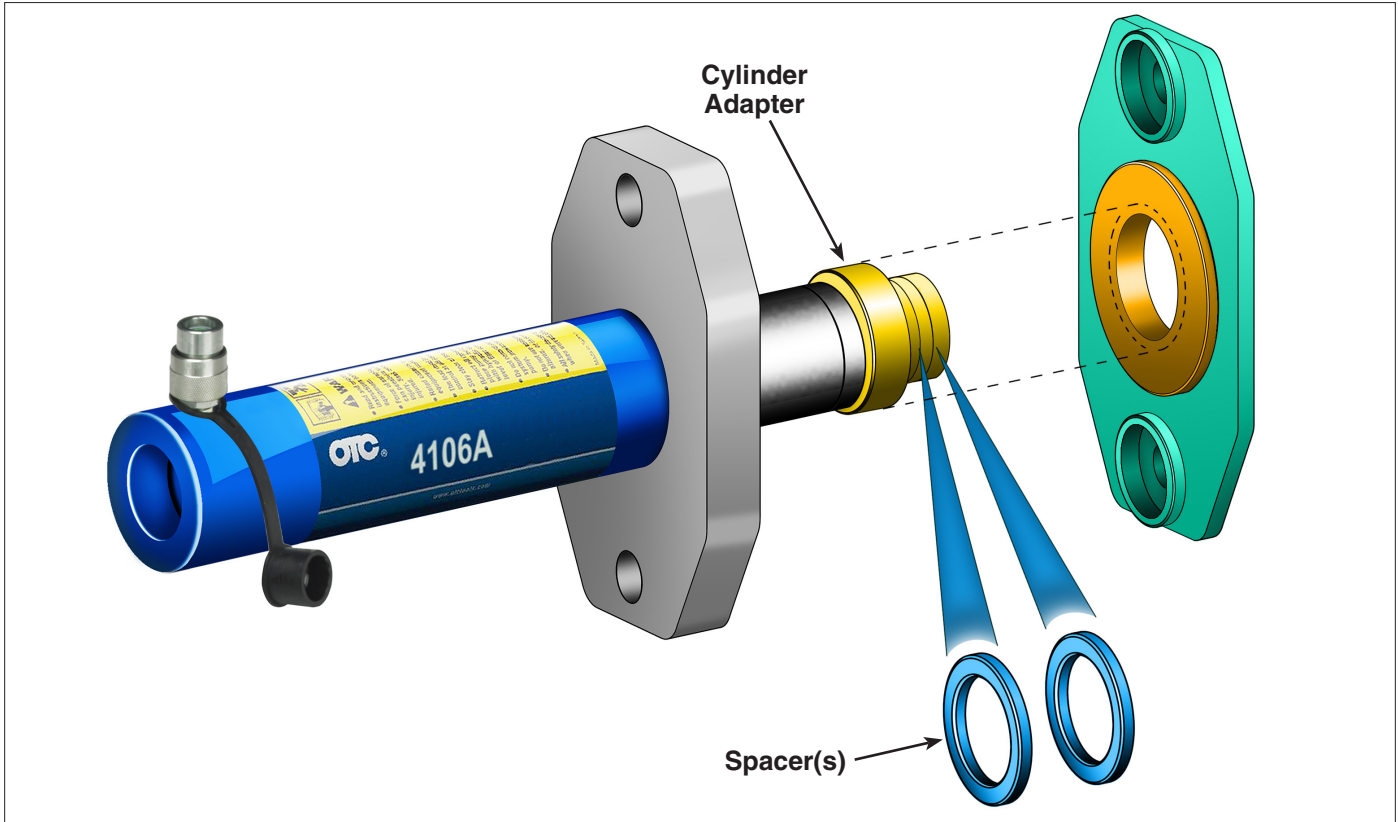



# Adapter Kits

---

The chart below outlines the Hendrickson Suspension Tool packages and Adapter Kits available for specific Hendrickson applications. If you currently own one tool package, consider purchasing adapter kits for other specific applications.

Hendrickson Tool Package Part No.		No. 2510A Air/Hyd. Pump (w/ hose & coupler)	No. 4263 Bare Tool	Hendrickson Adapter Kits available		
				No. 4250 (Volvo, Navistar, and Paccar)	No. 4254 (Comfort Air, Primaxx EX, and FCCC V-Ride)	No. 4255 (AIRTEK NXT [rear bushing only])
4246	Tool Packages include items marked w/ ✓		✓		✓	
4247		✓	✓		✓	
4261		✓	✓			✓
4274			✓	✓		
4275		✓	✓	✓		

# Inspection and Maintenance

---



**CAUTION:** To prevent personal injury,

- Only qualified personnel shall perform inspections to this Hendrickson Front Suspension Bushing Tool.
- Before each use, an approved inspector must inspect the suspension bushing tool for bends, cracks, dents, elongated holes, or missing hardware. If damage is found, discontinue use.
- Use only those repair parts called out in the parts list in this document. Items found in the parts list have been carefully tested and selected by OTC.

## Maintenance

To prevent contamination from entering the hydraulic system and damaging the cylinder, keep the cylinder clean. When the cylinder is not in use, keep the piston rod fully retracted and stored upside down. Use protective covers on disconnected quick couplers.

## Disposal

At the end of its useful life, dispose of the suspension bushing tool according to federal, state, and local regulations.



**Order replacement parts  
at [OTCparts.com](http://OTCparts.com)**

This document contains product parts lists and information regarding operation and maintenance. Items listed in the parts list have been carefully tested and selected by OTC. Therefore, use only OTC replacement parts.

Product questions may be directed to the OTC Technical Service Department at (800) 533-6127.



655 Eisenhower Drive  
Owatonna, MN 55060 USA  
Phone: (507) 455-7000  
Tech. Serv.: (800) 533-6127  
Fax: (800) 955-8329  
Order Entry: (800) 533-6127  
Fax: (800) 283-8665  
International Sales: (507) 455-7223  
Fax: (507) 455-7063