

# Tech 2

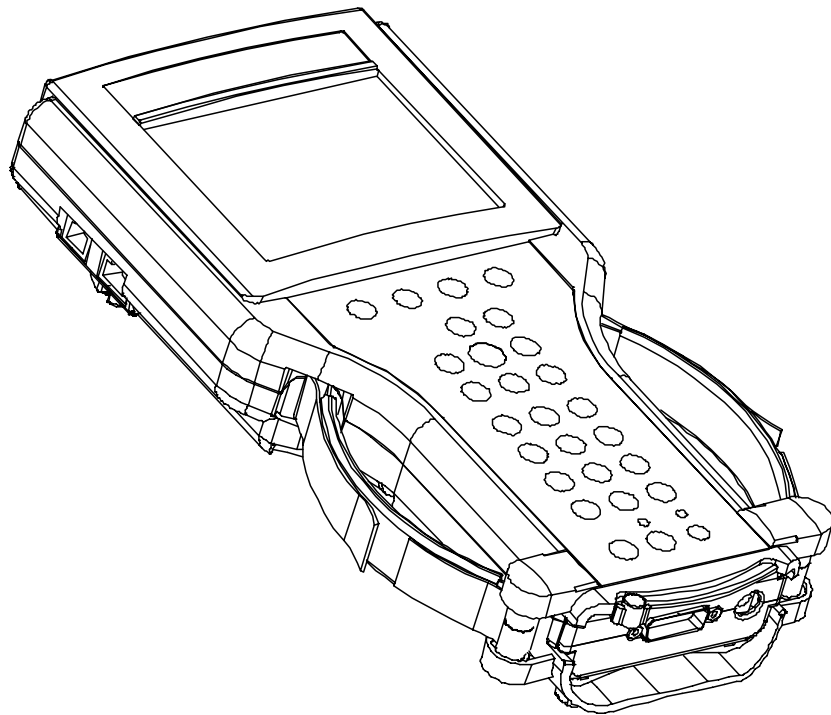

**Vetronix Corporation**

Copyright © 2006

Manual P/N 08002927

**Tech 2**<sup>®</sup> is a registered trademark of Vetronix Corp.

Printed in USA 9/06

This entire document and all information contained herein are proprietary, confidential, and exclusive trade secret property of Vetronix Corporation, and shall not be reproduced, duplicated, or copied in whole or in part, or made available to any person, firm, or corporation without the prior written permission of Vetronix Corporation.

# CUSTOMER SUPPORT OVERVIEW

To obtain assistance with a question or problem concerning the operation of your Vetronix product and its attached products, or to arrange for warranty and non-warranty repairs, telephone the Vetronix Customer Support Center. To order replacement parts, contact Vetronix Customer Service.

## BEFORE CALLING

Before making a call to Customer Support:

- Name and address
- Serial number of equipment or tool
- Name, part number and quantity of the item to be requested
- Telephone number where the technician may be reached

Prepare a brief description of the problem, which:

- Tells when the problem occurred
- Lists any error codes displayed
- Tells what accessories were being used when the problem occurred, and vehicle information

## MAKING THE CALL

The Vetronix Customer Support Center operates from 7:30 a.m. to 4:30 p.m. (Pacific standard time) Monday to Friday.

In the **United States** and **Canada** to contact Customer Support, dial:

- English     1-800-321-4889

A Vetronix Customer Support representative will come on the line or respond by fax to answer questions, make suggestions, and take repair and parts orders. To make sure every problem is resolved to the satisfaction of the caller, the Vetronix Customer Support representative will record each problem, question, or suggestion into a special problem tracking system. Any problems that cannot be resolved over the phone will be directed to the appropriate group for resolution.

---

## **TECH 2 USER'S GUIDE**

This user's guide is designed to provide a comprehensive overview of the Tech 2.

Everything contained in this manual is based on the latest product information available at the time of publication. The right is reserved to make changes at any time without notice.

No part of this publication may be reproduced, stored in any retrieval system, or transmitted in any form by any means, including but not limited to electronic, mechanical, photocopying, recording, or otherwise, without the prior written permission of the Vetronix Corp. This includes all text, illustrations, tables, and charts.

Requests for permission should be sent to:

Vetronix Corp.  
2030 Alameda Padre Serra  
Santa Barbara, CA 93103-1716  
U.S.A.

---

---

## DECLARATION OF CONFORMITY

according to ISO/IEC Guide and EN 45014

Manufacturer's Name: Vetronix Corporation  
Manufacturer's Address: Vetronix Corporation  
2030 Alameda Padre Serra  
Santa Barbara, CA 93105

declares, that the product

Product Name: Tech 2  
Model Number(s): 03006541-003  
Product Options: ALL

conforms to the following Product Specifications:

Safety: IEC 1010-1: 1990 + A1 / EN 61010-1: 1993  
EMC: CISPR 11: 1990 / EN 55011 1991 - Class A  
EN 50082-1: 1992  
IEC 801-2: 1991 / prEN 55024-2 1992 - 3kV  
CD, 8kV AD  
IEC 801-3: 1984 / prEN 55024-3 1991 - 3V/m  
IEC 801-4: 1988 / prEN 55024-4 1992 - 0.5 kV  
Signal Lines. 1kV Power Lines

### Supplementary Information:

This is a Class A product. In a domestic environment this product may cause radio interference in which case the user may be required to take adequate measures.

The product herewith complies with the requirements of the Low Voltage Directive 73/23/EEC and the EMC Directive 89/336/EEC.

---

---

## SOFTWARE LICENSE AGREEMENT

Please read this license agreement carefully before proceeding to operate the equipment. Rights to the software are offered only on the condition that the customer agrees to all terms and conditions of the license agreement. Proceeding to operate the equipment indicates your acceptance of these terms and conditions.

1. **USE:** Customer may use the software only on the computer system on which it was originally installed. Customer may not reverse assemble or decompile software unless authorized by law.
2. **OWNERSHIP:** Customer agrees that it does not have any title or ownership of the software, other than ownership of the physical media. Customer acknowledges and agrees that the software is copyrighted and protected under the copyright laws. Customer acknowledges and agrees that the software may have been developed by a third party software supplier named in the copyright notices included with the software, who shall be authorized to hold the Customer responsible for any copyright infringement or violation of this agreement.
3. **TERMINATION:** Vetronix Corp. may terminate this software license for failure to comply with any of these terms provided Vetronix Corp. has requested Customer to cure the failure and Customer has failed to do so within thirty (30) days of such notice.

## LIMITED WARRANTY

**SOFTWARE:** VTX warrants for a period of ninety (90) days from the date of purchase that the VTX software product will execute its programming instructions when properly installed. VTX does not warrant that the operation of the VTX software will be uninterrupted or error free. In the event that this VTX software product fails to execute its programming instructions during the warranty period, the remedy shall be a replacement of such software product.

**LIMITATION OF WARRANTY:** VTX makes no other express warranty, whether written or oral with respect to this product. Any implied warranty of merchantability or fitness for or a particular purpose is limited to the 90-day duration of this written warranty. Some states or provinces do not allow limitations on how long an implied warranty lasts, so the above limitation or exclusion may not apply to you.

**EXCLUSIVE REMEDIES:** The remedies provided above are Customer's sole and exclusive remedies. In no event shall VTX be liable for any direct, indirect, special, incidental or consequential damages (including lost profit) whether based on warranty, contract, tort or any other legal theory.

---

---

# Table of Contents

<b>1. INTRODUCTION</b> .....	1-1
USING THIS MANUAL .....	1-1
VEHICLE SYSTEM FAMILIARITY .....	1-1
THINGS YOU SHOULD KNOW .....	1-2
TECH 2 DISCLAIMER .....	1-2
FCC COMPLIANCE .....	1-2
VDE CERTIFICATION (FOR EUROPEAN USE) .....	1-3
TAKING THE PRODUCT BACK AND RECYCLING .....	1-3
.....	1-5
TECH 2 OVERVIEW .....	1-6
<i>Power Supply</i> .....	1-6
<i>Commands</i> .....	1-6
<i>Data Storage</i> .....	1-6
<i>Hardware</i> .....	1-6
<i>Mechanical Dimensions</i> .....	1-7
<i>Environmental Specifications</i> .....	1-8
WARRANTY .....	1-8
<i>Technician Notes</i> .....	1-10
<b>2. CARE AND CLEANING</b> .....	2-1
CLEANING THE DISPLAY .....	2-1
CLEANING THE KEYPAD .....	2-2
MAINTAINING THE CABLE ASSEMBLIES AND CONNECTORS .....	2-2
STORING THE TECH 2 .....	2-2
<b>3. GETTING STARTED</b> .....	3-1
INITIAL HARDWARE INSTALLATION .....	3-2
PCMCIA CARD REMOVAL .....	3-5
PCMCIA CARD INSERTION .....	3-6
VEHICLE COMMUNICATIONS INTERFACE MODULE REMOVAL .....	3-7
HAND STRAP ADJUSTMENT .....	3-8
TECH 2 KEYPAD .....	3-9
CONTROL KEYS .....	3-10
TECH 2 SOFT KEYS .....	3-11

SELECTION KEYS .....	3-12
ACTION KEYS .....	3-13
FUNCTION KEYS .....	3-14
HELP KEY .....	3-15
TECH 2 CONNECTIONS TO VEHICLE .....	3-16
TECH 2 CONNECTION TO PC .....	3-17
<b>4. POWER SUPPLIES .....</b>	<b>4-1</b>
CIGARETTE LIGHTER POWER CABLE .....	4-1
BATTERY POWER CABLE .....	4-2
NAO POWER SUPPLY .....	4-3
<b>5. ADAPTERS .....</b>	<b>5-1</b>
DLC CABLE .....	5-1
RS-232 CABLE .....	5-2
RS-232/DB9 ADAPTER .....	5-3
RS-232 LOOPBACK ADAPTER .....	5-3
<b>6. TROUBLESHOOTING .....</b>	<b>6-1</b>
POWER ON SELF TEST (POST) .....	6-1
SELF TESTS .....	6-2
<i>Tech 2 Self Test Main Menu</i> .....	6-4
NO POWER TO TECH 2 TROUBLESHOOTING TABLES .....	6-16
CIGARETTE LIGHTER POWER CABLE 3-AMP FUSE REPLACEMENT .....	6-19
BATTERY POWER CABLE 3-AMP FUSE REPLACEMENT .....	6-20
<b>7. ABBREVIATIONS .....</b>	<b>7-1</b>
<b>8. SOFTWARE .....</b>	<b>8-1</b>
TECH 2 FLOWCHART .....	8-2
<i>Diagnostics</i> .....	8-2
<i>Service Programming and View Captured Data</i> .....	8-4
<i>Tool Options and Getting Started</i> .....	8-5
<i>Tool Options</i> .....	8-6
<i>Getting Started</i> .....	8-13
TECHLINE INFORMATION SYSTEM 2000 (TIS 2000) .....	8-15
<i>Glossary</i> .....	8-16
SERVICE PROGRAMMING SYSTEM (SPS) .....	8-17



---

<i>Remote SPS Programming</i>	8-18
<i>Performing Remote SPS</i>	8-18
<i>Verifying Reprogramming</i>	8-25
<b>SOFTWARE DOWNLOAD</b>	8-25
<i>Tech 2 Update Procedures</i>	8-26
<b>SNAPSHOT UPLOAD</b>	8-30
<i>Uploading the Snapshot to the PC</i>	8-31
<i>Viewing the Snapshot</i>	8-34
<i>Replaying the Snapshot</i>	8-34
<i>Single-Column versus Two-Column Display</i>	8-34
<i>Displaying Diagnostic Trouble Codes</i>	8-35
<i>Displaying Graphs</i>	8-37
<i>Lock/Unlock Parameters</i>	8-39
<i>Viewing Capture Info Data</i>	8-40
<i>Saving a Snapshot to Disk</i>	8-40
<i>Printing a Snapshot</i>	8-41
<b>TECH 2 PATHING TABLES</b>	8-43
<i>Powertrain Pathing Tables</i>	8-43
<i>Body Pathing Table</i>	8-54
<i>Chassis Pathing Table</i>	8-66



# 1. INTRODUCTION

---

## USING THIS MANUAL

To increase their effectiveness with the Tech 2, familiarize yourself with the format and information contained in this guide.

## VEHICLE SYSTEM FAMILIARITY

While the Tech 2 is a powerful tool, it cannot replace knowledge and skill. To get the most out of the Tech 2, you must have a complete understanding of vehicle systems.

When using the Tech 2 to diagnose a vehicle, we recommend that you also refer to the service manual and the latest service bulletins.

## THINGS YOU SHOULD KNOW

### CAUTION!



When performing any checks with the engine running in an enclosed space such as a garage, make sure there is proper ventilation. Never inhale exhaust gases; they contain carbon monoxide, a colorless, odorless, extremely dangerous gas that can cause unconsciousness or death.

### CAUTION!



To help avoid personal injury, always set the parking brake securely and block the drive wheels before performing any checks or repairs on the vehicle.

## TECH 2 DISCLAIMER

The Tech 2 is designed for use by trained service personnel only. It has been developed for the sole purpose of diagnosing and repairing automotive systems with electronic controls and interfaces. Every attempt has been made to provide complete and accurate technical information based on factory service information available at the time of publication. However, the right is reserved to make changes at any time without notice.

## FCC COMPLIANCE

This equipment has been tested and found to comply with the limits for a Class A digital device, pursuant to Part 15 of the FCC rules. These limits are designed to provide reasonable protection against harmful interference when the equipment is operated in a commercial environment. This equipment generates, uses, and can radiate radio frequency energy. If not installed and used in accordance with the instruction manual, it may cause harmful interference to radio communications. Operation of this equipment in a residential area is likely to cause harmful interference, in which case the user will be required to correct the interference at his or her own expense.

## VDE CERTIFICATION (FOR EUROPEAN USE)

This equipment complies with the requirements of VDE 0871/6.78. Improper use or maintenance neglect may cause unacceptable radio or TV interference.

### CAUTION!



The Tech 2 uses parts that can produce arcs or sparks. When used in a garage environment, the Tech 2 must be located not less than 18 inches (460 mm) above the floor.

### NOTE



- Do NOT clasp battery clips together when connected simultaneously to the vehicle's 12-volt cigarette lighter or power supply. Reverse polarity in the vehicle's cigarette lighter may be present. Damage may occur to the Tech 2 or to the vehicle.
- If power is applied to the Tech 2 and the display remains blank, reverse polarity in the cigarette lighter may be present. Damage to the Tech 2 could occur. Do NOT connect the DLC cable to the vehicle. Verify that the center contact of the vehicle's cigarette lighter has +12 volts and that the outer contact is grounded.
- Turn off the power before inserting or removing the PCMCIA card. Continual removal and reinsertion of this card is not recommended.
- Align all cards and components carefully before inserting them into the Tech 2.
- Make sure all cables and adapters are firmly connected before starting to use the Tech 2.
- Always read the instructions completely before attempting a new procedure.
- Do not connect the RS-232 and RS-485 ports to a direct phone line. The Tech 2 was not designed for this method of communication.
- Do not place the Tech 2 so that the tilt stand can make contact with the vehicle battery terminal as this could short out the battery.

## TAKING THE PRODUCT BACK AND RECYCLING

Applicable to product that is sold into the European Union, the European Union has passed a directive called Waste Electrical and Electronic Equipment, or WEEE for short, to ensure that systems are setup throughout the EU for the collection, treating and recycling of electronic waste.

This ensures that the devices are recycled in a resource-saving way representing no danger to health or the environment.



FIGURE 1-1. WEEE Logo

The WEEE symbol (see [Figure 1-1](#)) on the product or its packaging shows that the product must not be disposed of as residual garbage. The user is obliged to collect the old devices separately and return them to the WEEE take-back system for recycling.

The WEEE directive concerns all Bosch devices but not external cables or batteries. For more information on the Bosch GmbH Recycling Program, contact one of the Vetronix/Bosch Group sales and service locations listed below.

## Bulgaria

### I.C İletisim Teknolojileri Elek. San. Ve Tic. Ltd. Sti.

Bayar Cad. Bayar Is Merkezi NO: 109A D:8  
81090 Kozyatagi, Istanbul  
Turkey

Phone: +90 (216) 445 90 12  
Fax: +90 (216) 445 90 13  
Email: [info@icteknoloji.com](mailto:info@icteknoloji.com)  
WWW: [www.icteknoloji.com](http://www.icteknoloji.com)

## Ireland

### Advanced Diagnostics

Unit 5  
Alliance Close  
Attleborough Fields Industrial Estate  
Nuneaton  
Warwickshire, CV11 6SD

Phone: 44 24 76757951  
Fax: 44 24 76757952  
Email: [shaun@advanceddiagnostics.co.uk](mailto:shaun@advanceddiagnostics.co.uk)  
WWW: [www.advanceddiagnostics.co.uk](http://www.advanceddiagnostics.co.uk)

## Romania

### I.C İletisim Teknolojileri Elek. San. Ve Tic. Ltd. Sti.

Bayar Cad. Bayar Is Merkezi NO: 109A D:8  
81090 Kozyatagi, Istanbul  
Turkey

Phone: +90 (216) 445 90 12  
Fax: +90 (216) 445 90 13  
Email: [info@icteknoloji.com](mailto:info@icteknoloji.com)  
WWW: [www.icteknoloji.com](http://www.icteknoloji.com)

## Slovenia

### GIIR d.o.o

Gabrovacki out II deo 32a  
18000 Nis  
Serbia & Montenegro  
(Yugoslavia)

Cell: #381 65 4000068  
Office: #381 18 534-272  
Fax: #381 338 832  
Email: [giir@bankerinter.net](mailto:giir@bankerinter.net)

## **United Kingdom**

### **Advanced Diagnostics**

Unit 5  
Alliance Close  
Attleborough Fields Industrial Estate  
Nuneaton  
Warwickshire, CV11 6SD

Phone: 44 24 76757951  
Fax: 44 24 76757952  
Email: [shaun@advanceddiagnostics.co.uk](mailto:shaun@advanceddiagnostics.co.uk)  
WWW: [www.advanceddiagnostics.co.uk](http://www.advanceddiagnostics.co.uk)

## TECH 2 OVERVIEW

The Tech 2 is a hand-held computer designed to aid in the diagnosis and repair of automotive systems with electronic controls and interfaces.

### POWER SUPPLY

**The Tech 2 can be powered from:**

- The automobile battery power cable
- The cigarette lighter power cable
- The Tech 2 power supply
- The DLC (Data Link Connector) connection in some vehicles

### COMMANDS

**The Tech 2 prompts you to enter commands via the membrane keypad for:**

- Retrieving and viewing diagnostic information.
- Selecting self tests.
- Performing vehicle diagnostics.

### DATA STORAGE

The Tech 2 contains electronic components called PCMCIA (Personal Computer Memory Card Industry Association) cards, which store diagnostic programs. The Tech 2 can be updated as vehicle models change by reprogramming the PCMCIA card via the RS-232 connector.

### HARDWARE

**The Tech 2 has been designed as a rugged, shop-ready tool by having:**

- A sturdy case
- A sealed keypad
- Heavy-duty cables and connectors

You can expect years of trouble-free service if you take reasonable care of the Tech 2 and follow the maintenance procedures outlined in this chapter.



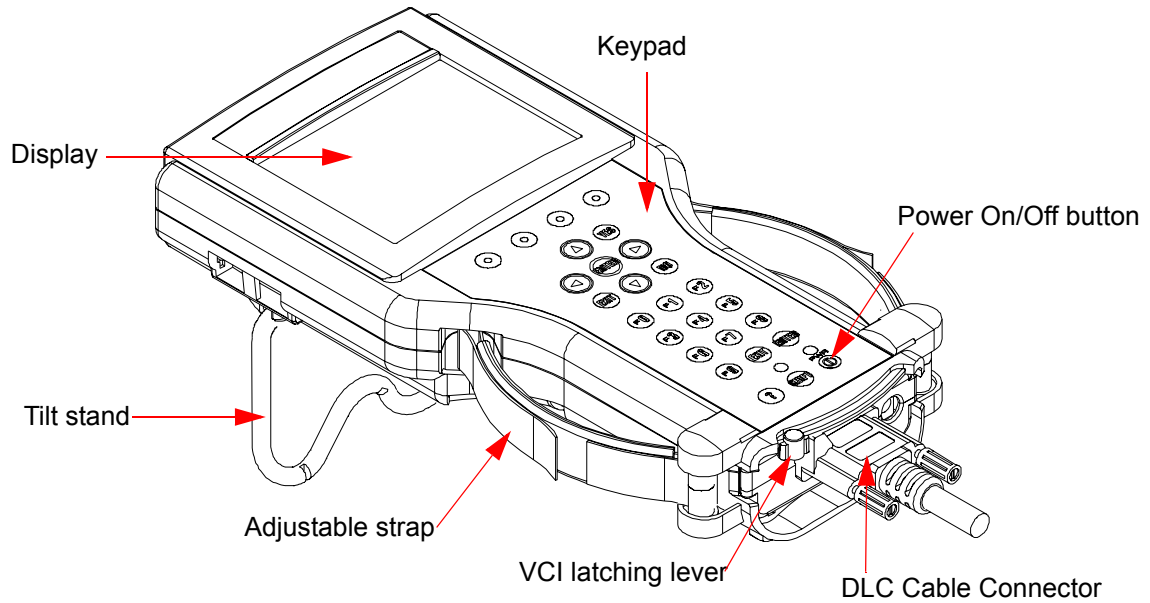

FIGURE 1-2. External Features of the Tech 2 (Front View)

## MECHANICAL DIMENSIONS

The dimensions of the Tech 2 are as follows:

<b>Width</b>	6.1 inches (155 mm)
<b>Height</b>	11.8 inches (300 mm)
<b>Depth</b>	2.0 inches (55 mm)
<b>Weight</b>	2.2 pounds (1.0 kg)

TABLE 1-1. Mechanical Dimensions

## ENVIRONMENTAL SPECIFICATIONS

Conditions	Specifications
Temperature	Operating: 0° to 40°C (32° to 104°F)
	Non-Operating: -40° to 70°C (-40° to 158°F)
Relative Humidity	Operating: 15% to 95% at 40°C (non-condensing)
	Non-Operating: 90% at 65°C (non-condensing)

TABLE 1-2.

## WARRANTY

The Tech 2 is warranted against defects in materials and workmanship for 1 year. If your Tech 2 must be sent in for repair, contact Customer Support (see inside front cover).

**Important:** This warranty does not cover any part that has been abused, altered, used for a purpose other than which it was intended, or used in a manner inconsistent with instructions regarding use. This includes, but is not limited to, removal of any Tech 2 screws.

**Your Tech 2 is composed of a base kit and a variety of the following subcomponents:**

Product Number	Product Name
01002668	Vetronix Tech 2 Unit
Part Number	Base Kit
02002952	DLC cable
02002954	Cigarette lighter power
02002956	Battery power cable
02002955	SAE 16/19 pin adapter
02002953	DLC loopback adapter
01001089	PC Interface Kit
02001606	RS232 loopback adapter
02002971	Storage case
02002961	NAO 12/19 adapter

TABLE 1-3. Base Kit Parts List

<b>Product Number</b>	<b>Product Name</b>
01002668	Vetronix Tech 2 Unit
<b>Part Number</b>	<b>Base Kit</b>
02002972	NAO power supply
02002994-003	32 MB PCMCIA card

TABLE 1-3. Base Kit Parts List (Continued)

<b>Product Number</b>	<b>Product Name</b>
01002398	Vetronix Tech 2 Pro
<b>Part Number</b>	<b>Base Kit</b>
02002952	DLC cable
02002954	Cigarette lighter power
02002956	Battery power cable
02002955	SAE 16/19 pin adapter
02002953	DLC loopback adapter
01001089	PC Interface Kit
02001606	RS232 loopback adapter
02002971	Storage case
02002961	NAO 12/19 adapter
02002972	NAO power supply
02002994-003	32 MB PCMCIA card

TABLE 1-4. Pro Kit Parts List

## TECHNICIAN NOTES

A series of 20 horizontal dashed lines intended for technical notes.

## 2. CARE AND CLEANING

---

After using the Tech 2, a few simple steps will insure that you get the most life out of this diagnostic tool.

### NOTE



Do not spray or pour cleaner anywhere on the Tech 2. If the Tech 2 becomes dirty, clean it with mild detergent or hand soap. Avoid using harsh solvents, such as petroleum-based cleaning agents, acetone, benzene, trichlorethylene, etc. Harsh solvents can etch Tech 2 plastic surfaces.

Although the Tech 2 is water resistant, it is not waterproof, so be sure to dry the Tech 2 thoroughly prior to usage and/or storage.

### **Maintenance of the Tech 2 requires periodic inspection and cleaning of the following:**

- The display window
- The keypad
- The cable assemblies and connectors

Make sure the Tech 2 is not connected to a vehicle or other power source and follow the cleaning procedures detailed below.

## CLEANING THE DISPLAY

The display collects dust and grime during normal use. Occasionally wipe the screen with a clean, soft, static-free cloth. Remove stubborn stains by applying a non-abrasive glass cleaner to a soft cloth and wipe the cloth across the display area.

## **CLEANING THE KEYPAD**

Clean the keypad with a non-abrasive cleaner. Apply a small amount of cleaner on a soft cloth and wipe the cloth across the keypad area.

## **MAINTAINING THE CABLE ASSEMBLIES AND CONNECTORS**

Inspect cable assemblies during connection and disconnection to components. Watch for any cuts or abrasions along the cables. Check the connectors and connector pins for grease, dirt, and corrosion. If contaminants are present, remove them with a mild soap solution.

## **STORING THE TECH 2**

- Store the Tech 2 away from solvents and other liquids. It is NOT moisture proof.
- Store the Tech 2 away from direct sunlight. Ultraviolet and infrared light will darken the display.
- Store the Tech 2 in its plastic case. Otherwise, the high-impact plastic cover could become scratched.

# 3. GETTING STARTED

---

This section covers all Tech 2 vehicle applications and therefore some of the information provided may not be required for individual applications.

The Tech 2 contains two serial communication ports: the RS-232 and the RS-485. Use the RS-232 port for downloading data from another computer to the Tech 2. The RS-485 port is currently not used.

The Tech 2 also contains two PCMCIA ports, a power jack connector, and a Vehicle Communications Interface (VCI) connector. One of the PCMCIA slots contains a memory card with diagnostic information. The power jack accepts power from the AC/DC power supply, battery, or cigarette lighter power cable. The VCI connector accepts the DLC cable or DLC loopback adapter.

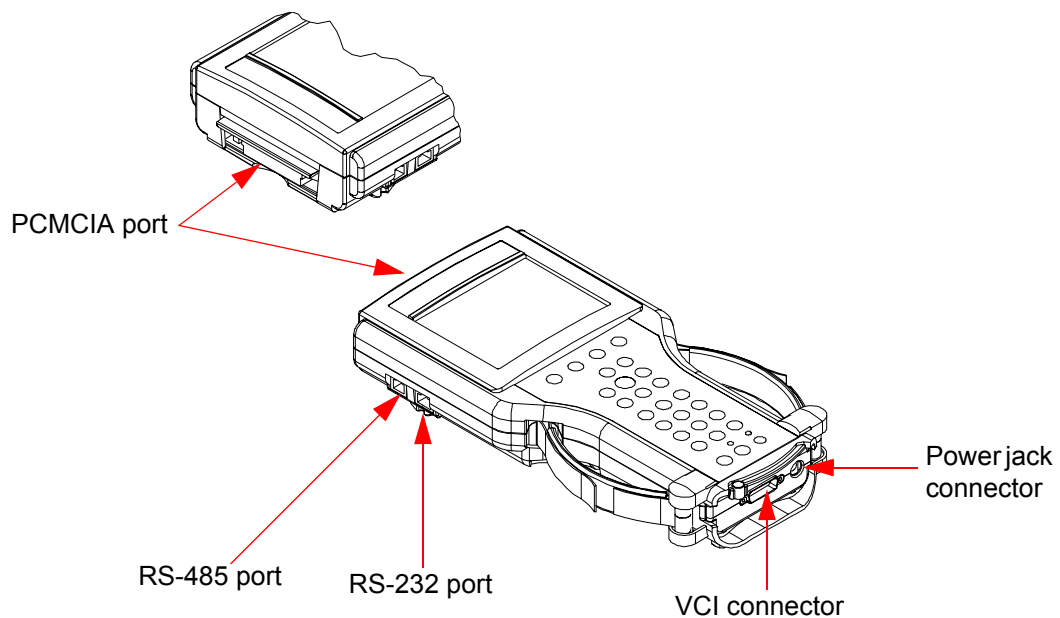

FIGURE 3-1. Identification of the Tech 2's External Ports

# INITIAL HARDWARE INSTALLATION

## The Tech 2 hardware initial installation requires the following steps:

1. Remove the RS-232 loopback adapter (P/N 02001606) from the storage case (P/N 02002971). Plug it into the RS-232 port (Figure 3-2).
2. Attach the Tech 2 DLC cable (P/N 02002952) to the VCI connector (Figure 3-3).
3. Locate the DLC loopback adapter (P/N 02002953) in the storage case. Attach it to the DLC cable (Figure 3-4).
4. Locate the NAO (P/N 02002972) power supply and appropriate power cord in the storage case. Insert the power jack into the Tech 2 DLC cable (Figure 3-5) or into the bottom of the Tech 2 next to DLC cable connector (Figure 3-6).
5. Turn on power by pressing the PWR button located on the Tech 2 key pad.
6. Tech 2 hardware is verified automatically by the POST Test (for information on this program, see Chapter 6).
7. Disconnect the RS-232 loopback adapter, the power supply, and the DLC loopback adapter and return to the Tech 2 storage case (Figure 3-7).

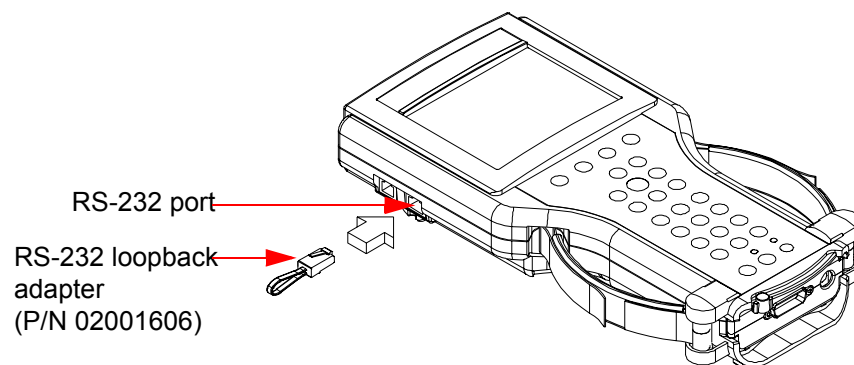

FIGURE 3-2. Connection of RS-232 Loopback Adapter to Tech 2 RS-232 Port



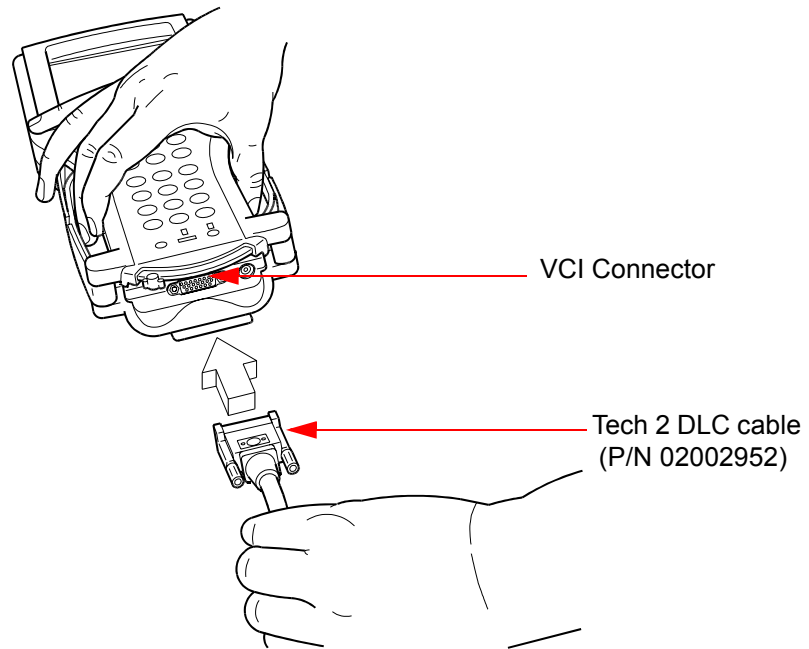

FIGURE 3-3. Connection of Tech 2 DLC Cable to the VCI Connector

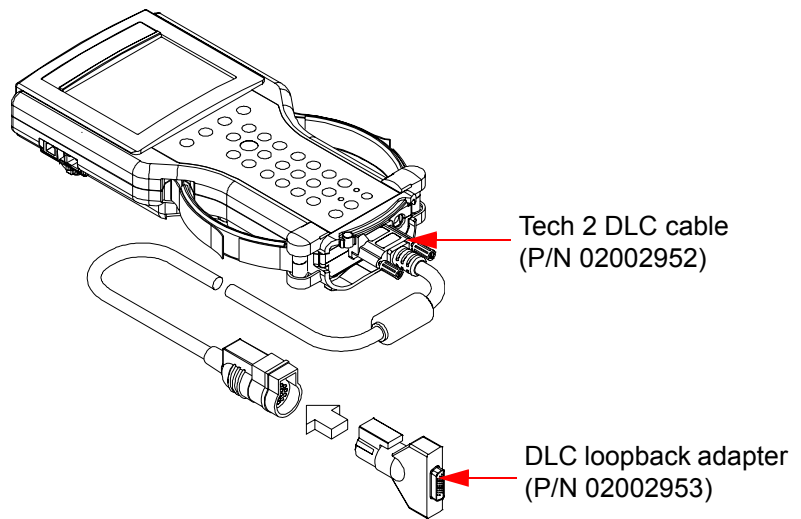

FIGURE 3-4. Connection of DLC Loopback Adapter to DLC Cable

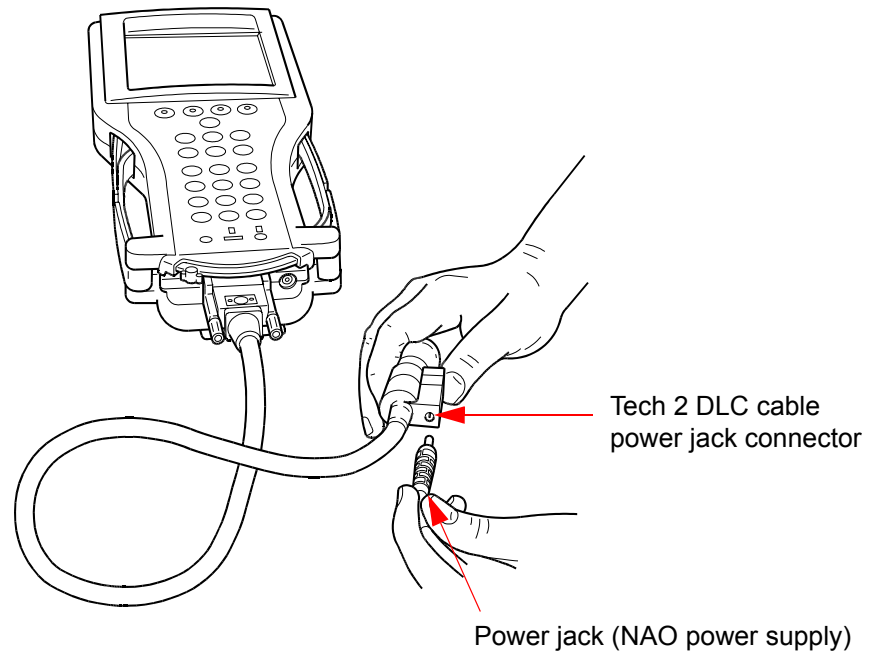

FIGURE 3-5. Connection of Power Jack to Tech 2 DLC Cable

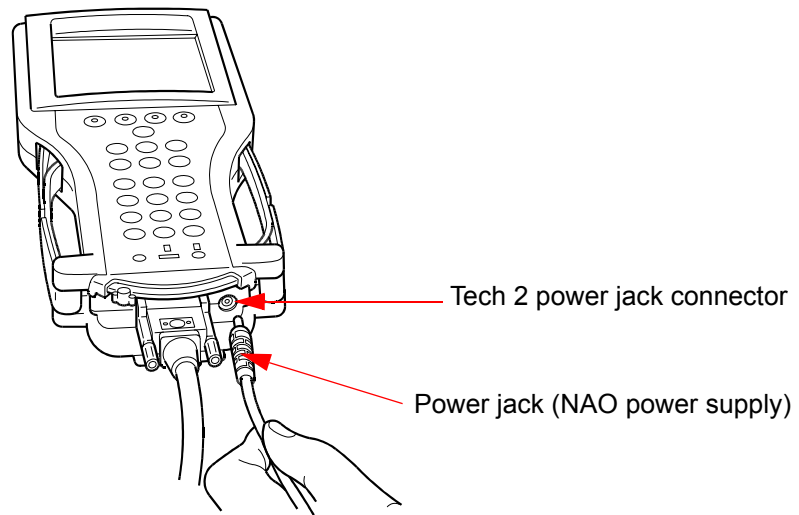

FIGURE 3-6. Connection of Power Jack to the Bottom of Tech 2

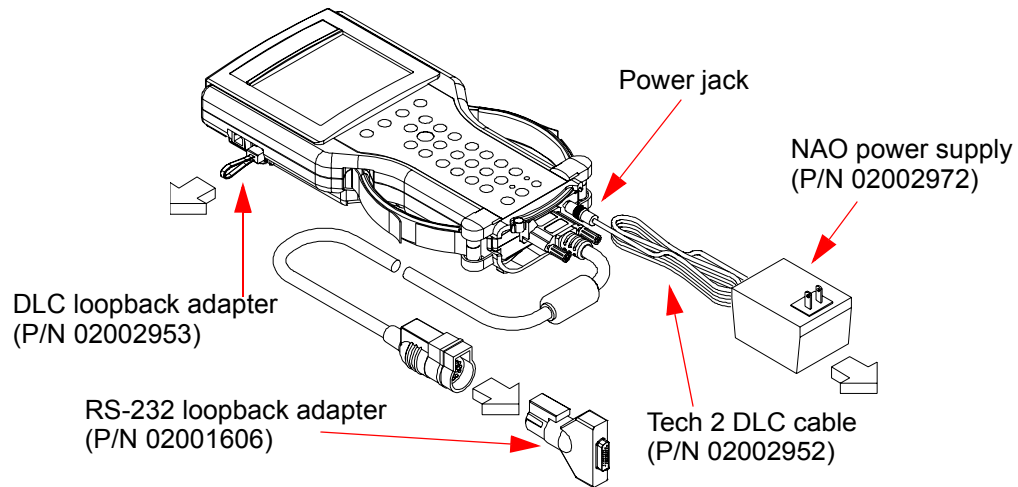

FIGURE 3-7. Disconnection of RS-232 Loopback Adapter, DLC Loopback Adapter, and Power Supply

#### NOTE



When using the Tech 2 for vehicle communications, the Tech 2 must be powered with the cigarette lighter power cable (P/N 02002954) to ensure a proper ground.

## PCMCIA CARD REMOVAL

The PCMCIA Card is accessed by opening the hinged door located at the top of the Tech 2. The card is found in the upper slot. The lower slot will be used for future enhancements. Press the "up arrow button" (located on the left hand side of the Tech 2) to eject the card (Figure 3-8).

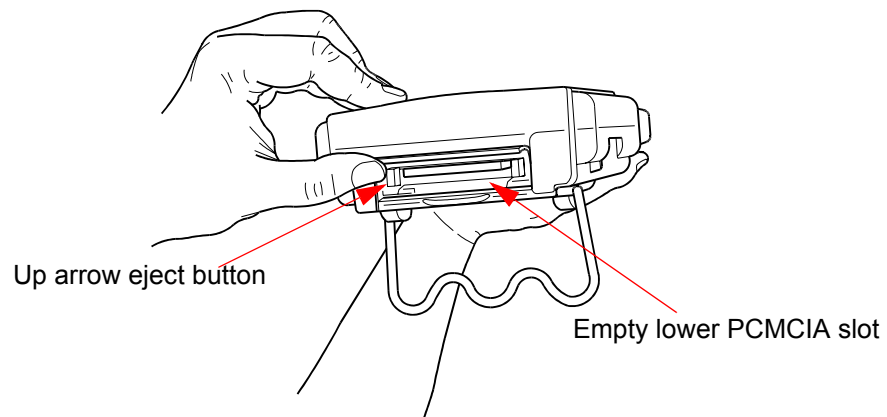

FIGURE 3-8. Ejection of PCMCIA Card

**CAUTION!**



Use only Vetronix supplied PCMCIA cards. The PCMCIA slots are designed to interface with 5-volt cards. Permanent damage to Tech 2 could occur if a 3.3-volt card is inserted into the Tech 2 PCMCIA connector.

## PCMCIA CARD INSERTION

The PCMCIA Card is keyed with two notches on one side and one notch on the other side (Figure 3-9). Make sure that the notches are in the correct position before inserting the card. Slowly insert the card (Figure 3-10) until it clicks into place.

Make sure the PCMCIA card is inserted into the upper slot. The card fits into both slots; however, if the card is placed in the lower slot, the Tech 2 will not function properly.

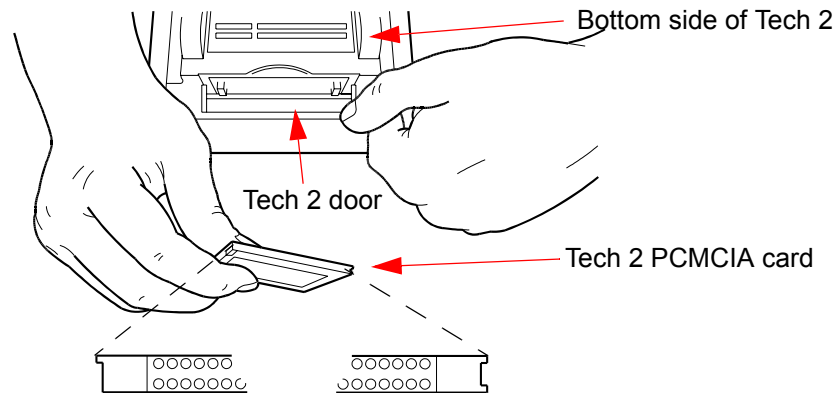

FIGURE 3-9. PCMCIA Card Keying

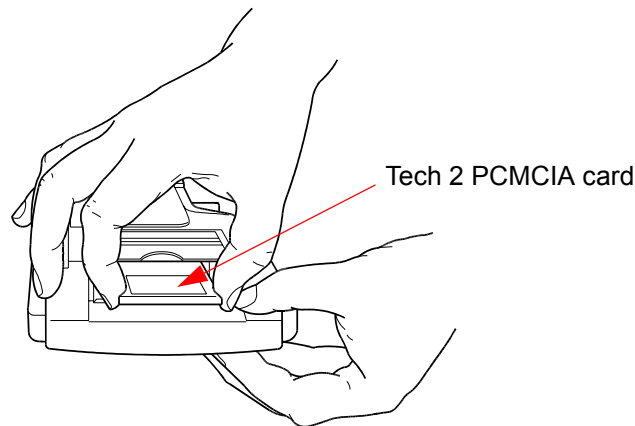

FIGURE 3-10. PCMCIA Card Insertion

## VEHICLE COMMUNICATIONS INTERFACE MODULE REMOVAL

The Vehicle Communications Interface (VCI) module is located at the lower end of the Tech 2. Removal of this module is required only if the VCI needs to be updated. To remove the module disconnect Tech 2 DLC cable if attached, move the lever (Figure 3-11) all the way toward the right side of the Tech 2 (Figure 3-12). The VCI module can now be removed.

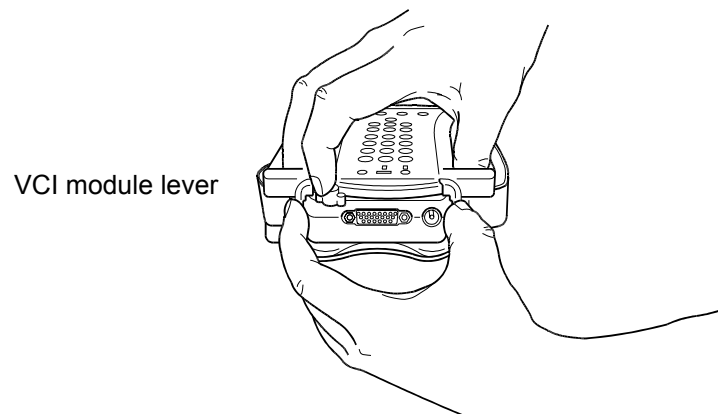

FIGURE 3-11. VCI Module Removal

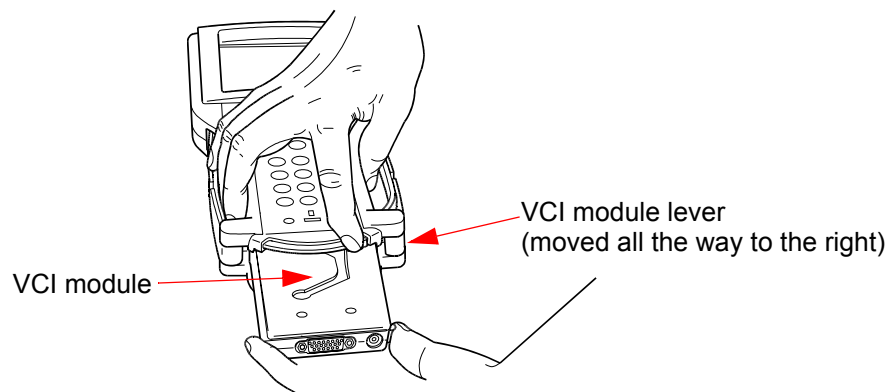

FIGURE 3-12. VCI Model Removed

## HAND STRAP ADJUSTMENT

The Tech 2 velcro hand straps may be adjusted for individual needs as shown in [Figure 3-13](#).

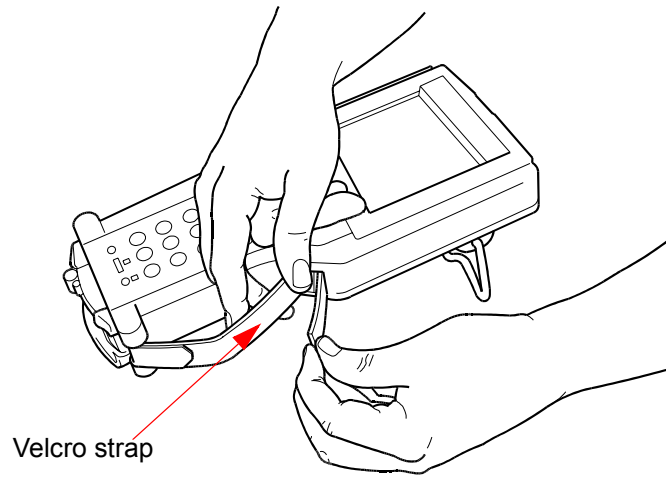

FIGURE 3-13. Tech 2 Hand Strap Adjustment

# TECH 2 KEYPAD

The Tech 2 keypad consists of six major keypad operation areas:

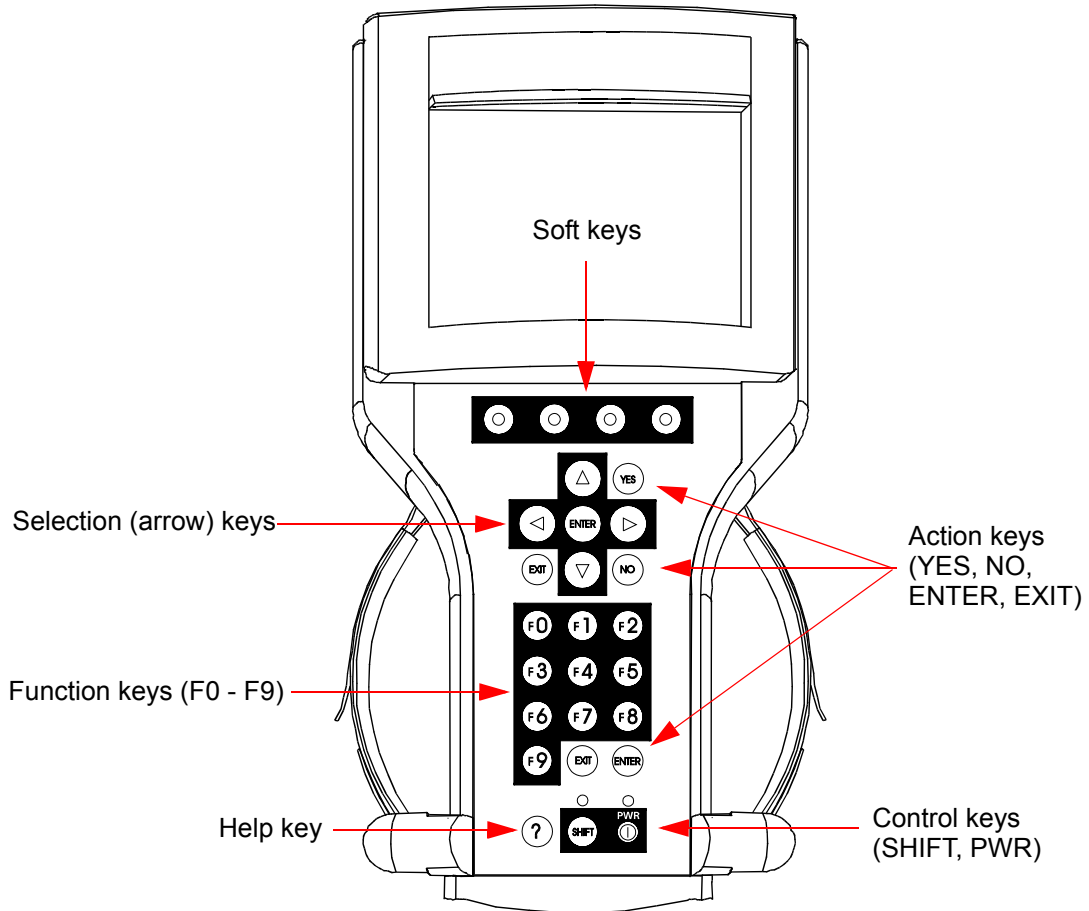

FIGURE 3-14. Tech 2 Keypad

## CONTROL KEYS

The [PWR] key is used to turn the Tech 2 on or off (Figure 3-15). The status indicator light above this key is illuminated green when the Tech 2 is operational.

The [SHIFT] key is used with the up and down arrow keys to change screen brightness and contrast (Figure 3-15).

### To adjust screen brightness and contrast, perform the following:

1. Press the [SHIFT] key once (amber status indicator light above [SHIFT] lights up).
2. Use up and down arrows to adjust screen brightness and contrast.
3. Press [SHIFT] key again when desired brightness is reached (status indicator light above [SHIFT] is off).

The Tech 2 should return to normal operation after following the above steps.

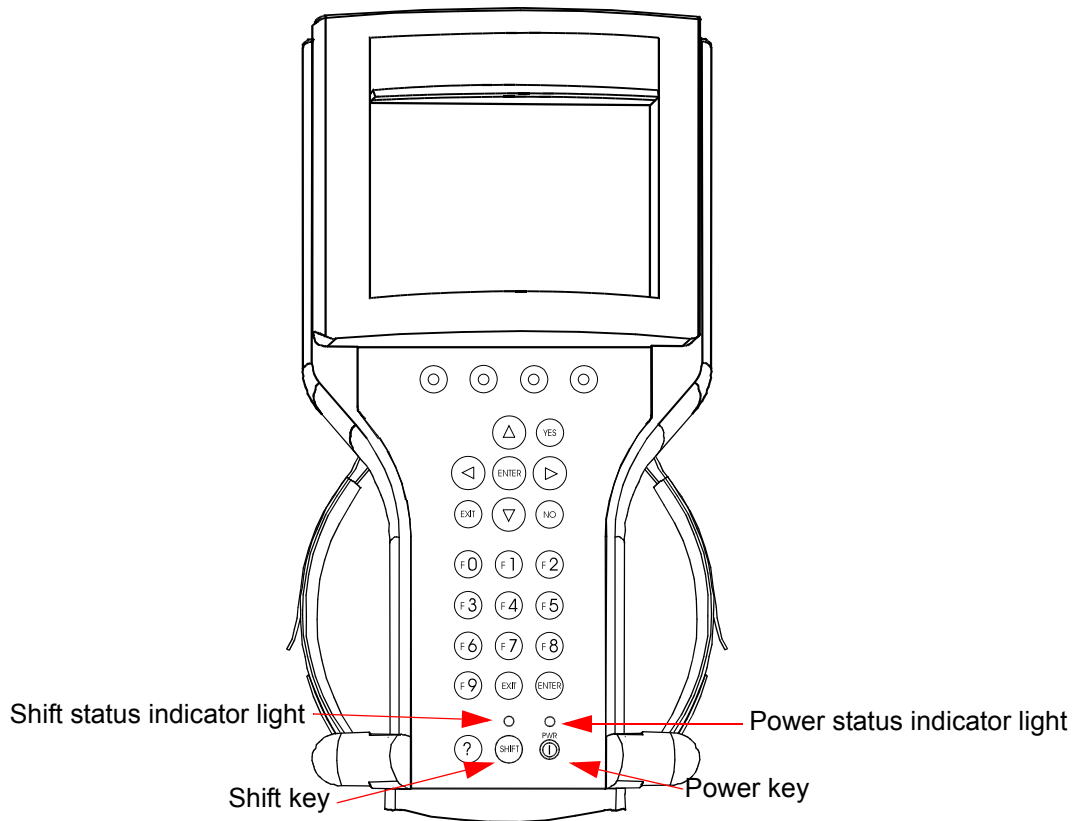

FIGURE 3-15. Location of Control Keys



## TECH 2 SOFT KEYS

Four soft keys are located directly below the Tech 2 screen (Figure 3-16). The soft keys correspond directly to the four possible selection boxes found at the bottom region of the Tech 2 screen. These selections may change from screen to screen and are under the control of the application software. To make a screen selection, press the corresponding soft key. In the example shown in Figure 3-17, the first soft key was pressed to select [Display Time].

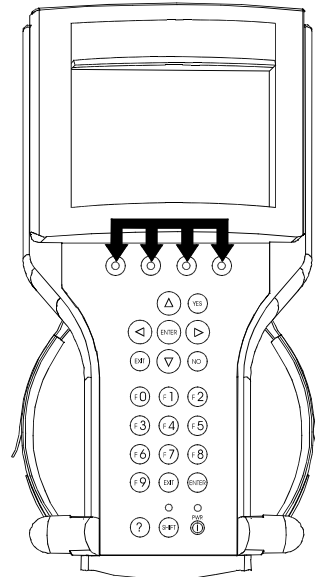

FIGURE 3-16. Location of Soft Keys

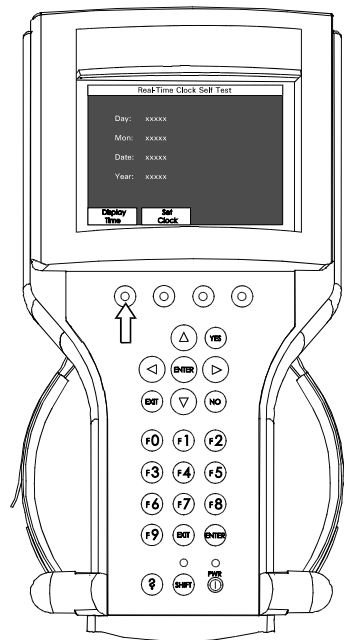

FIGURE 3-17. Soft Key Selection for [Display Time]

## SELECTION KEYS

The Tech 2 selection keys are four directional arrow keys (Figure 3-18). The arrow keys are pressed to move the highlighted area to a selection on the screen (Figure 3-19) or to scroll the screen if there is more than one screen. Once the desired selection is highlighted, press [ENTER] to activate the selection.

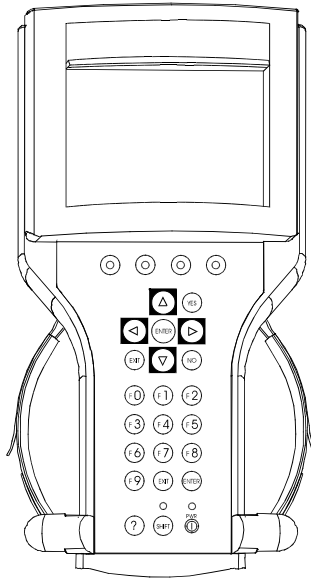

FIGURE 3-18. Location of Selection Keys

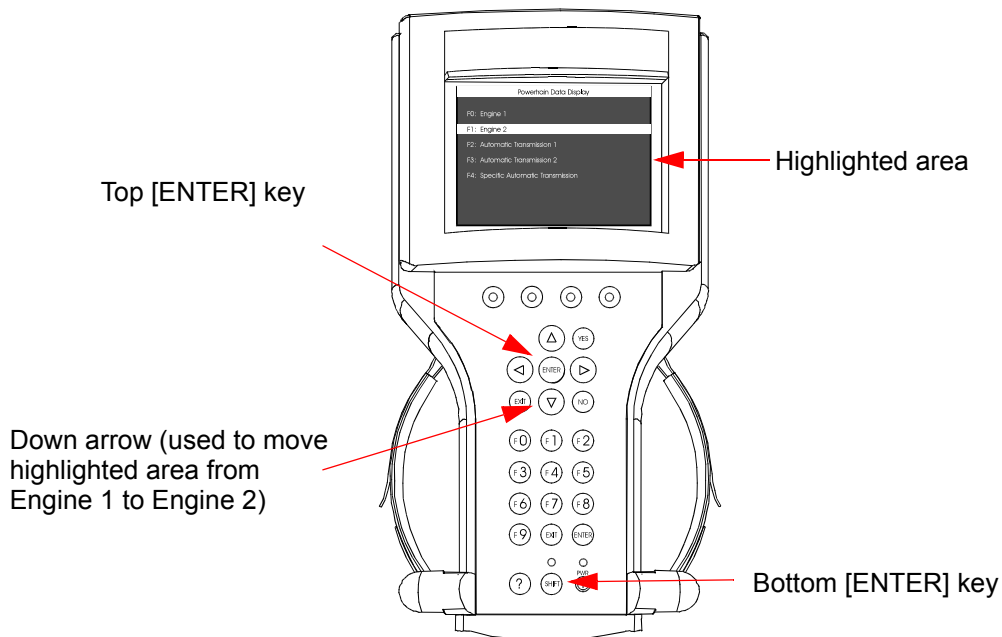

FIGURE 3-19. Positioning Highlighted Area to Make a Selection

## ACTION KEYS

Action keys are used to respond to a specific question, initiate an action, or to exit from the Tech 2 program (Figure 3-20). Specific "yes or no" questions often appear on the Tech 2 screen. The [YES] and [NO] keys are used to respond to these questions. Either of the two [ENTER] keys may be pressed to activate a menu selection. Either of the two [EXIT] keys may be pressed to leave the current Tech 2 screen and return to a previous screen.

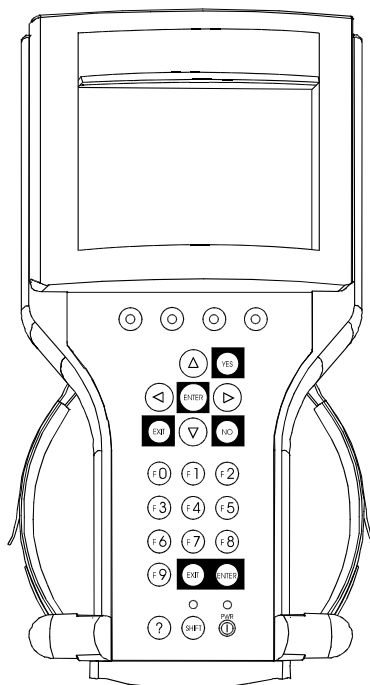

FIGURE 3-20. Location of Action Keys

## FUNCTION KEYS

Ten function keys (F0 to F9) are located on the Tech 2 keypad ([Figure 3-21](#)). A function key may be pressed to initiate a specific Tech 2 function. In some cases the function keys are used for numeric data entry. The arrow keys and [ENTER] may also be used to initiate a function selection, however, this may require additional keystrokes.

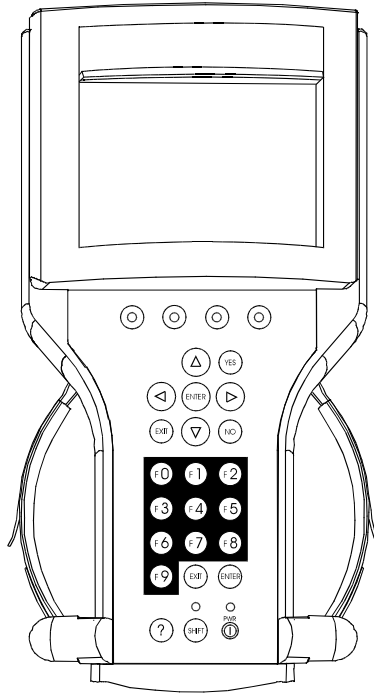

FIGURE 3-21. Location of Function Keys

## HELP KEY

The [?] key (Figure 3-22) may be pressed at any time to obtain a help screen. The help screen provides specific information relating to the operation of the Tech 2.

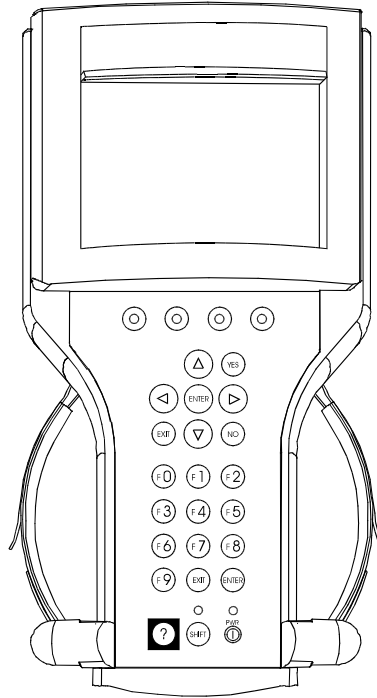

FIGURE 3-22. Location of Help Key

## TECH 2 CONNECTIONS TO VEHICLE

The Tech 2 receives power through the DLC cable connection to vehicles equipped with On-Board Diagnostics (OBD II) (Figure 3-23). In the case of vehicles *not* equipped with OBD II, an external power source such as a vehicle cigarette lighter must be used (Figure 3-24).

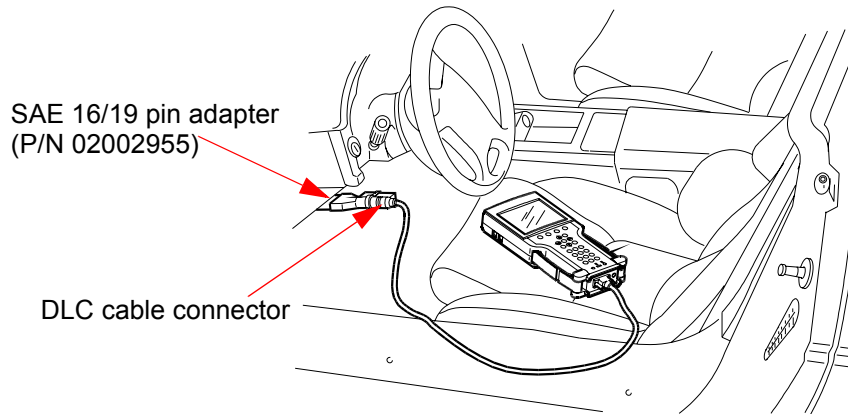

FIGURE 3-23. Attaching the Tech 2 to OBD II-Equipped Vehicles

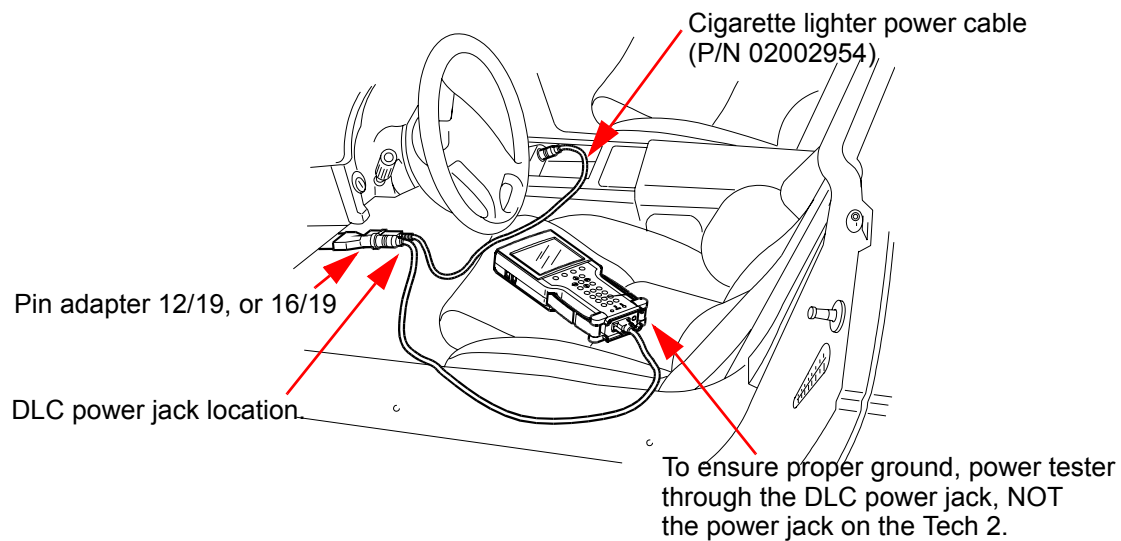

FIGURE 3-24. Attaching the Tech 2 to Non-OBD II-Equipped Vehicles

## TECH 2 CONNECTION TO PC

It may be necessary to connect the Tech 2 with a PC for the following reasons:

- Transfer of vehicle data (calibration information, "snapshot," etc.) from the Tech 2 to the PC
- Transfer of vehicle calibration data from the PC to the Tech 2
- Transfer of data (software update, etc.) from the PC to the Tech 2
- Before connecting Tech 2 to the PC, the following steps should be taken:
- Make sure that the RS-232 cable (P/N 02001358) is attached to the Tech 2 RS-232 port located on the left side of the Tech 2 (Figure 5-3).
- Make sure the appropriate power supply is connected to the DLC cable power jack connector (Figure 4-1), or to the power jack connector at the bottom of the Tech 2 (Figure 3-25).
- Make sure the PCMCIA card is fully inserted into the upper slot at the top of the Tech 2 (Figure 3-8, Figure 3-9, and Figure 3-10).

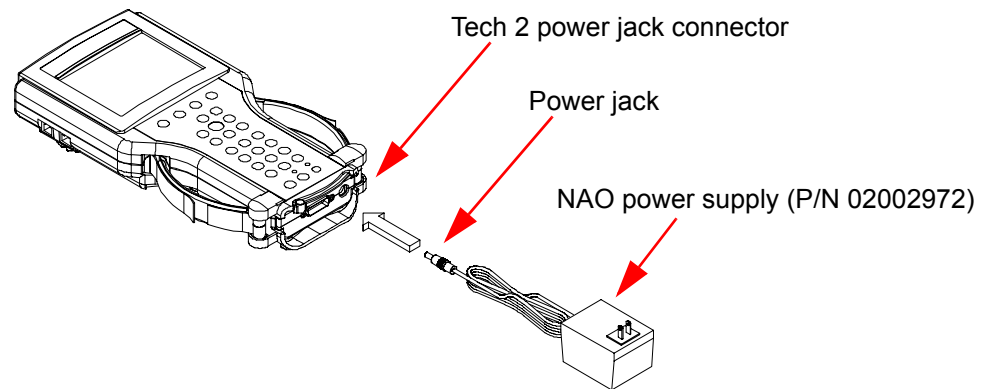

FIGURE 3-25. Tech 2 Connection to PC

Plug serial port adapter (P/N 01001089) into the unused serial port (com port) on the back of the computer terminal. Then plug the Tech 2's RS-232 cable into the serial port adapter and connect the appropriate power supply.

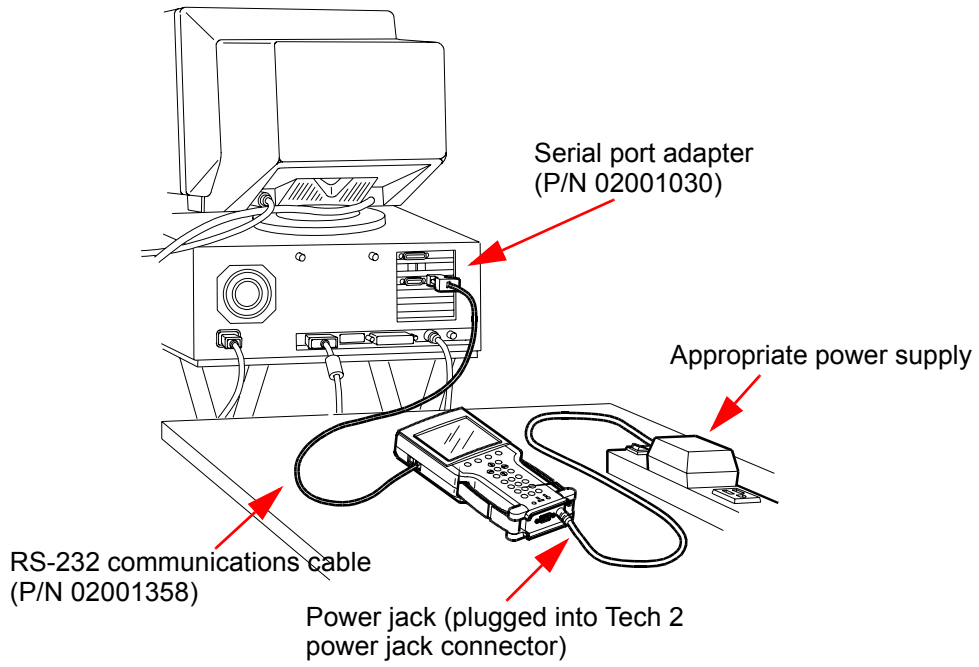

FIGURE 3-26. Tech 2 Connection to PC1



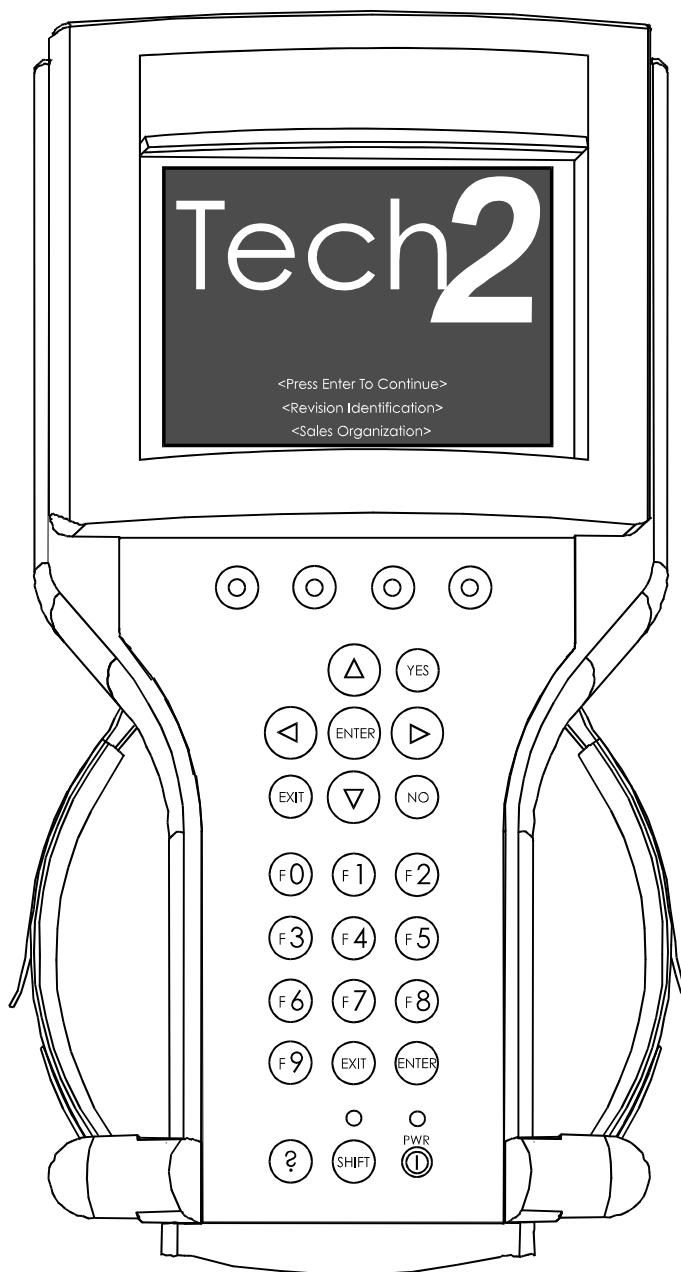

FIGURE 3-27. Tech 2 Start-Up Screen



# 4. POWER SUPPLIES

---

## Power up the Tech 2 using either:

- The power jack connector at the bottom of the Tech 2 unit ([Figure 4-1](#)), or
- The DLC cable power jack connector behind the area where various DLC adapters are connected ([Figure 4-1](#)).

For non-vehicle communications, connect the power source to either location.

For vehicle communications, connect the power source to the DLC cable power jack connector only. Proper grounding may not be present if the power source is connected directly to the Tech 2.

## **When the Tech 2 is connected to the DLC of an appropriate vehicle, the vehicle battery supplies power. When the Tech 2 is not connected to the vehicle's DLC, the DLC cable power jack connector accepts power from the following:**

- Cigarette lighter power cable ([Figure 4-1](#), see text below)
- Battery power cable ([Figure 4-1](#), see text below)
- NAO power supply ([Figure 4-1](#) and [Figure 4-2](#), see *NAO Power Supply* on [page 3](#))

If the DLC and external power source are both connected, the power jack connection supplies current to the Tech 2. In this instance, power from the vehicle's DLC connector is automatically disconnected from the Tech 2 internal power supply.

## CIGARETTE LIGHTER POWER CABLE

This cable contains one fuse and two connectors. It has a cigarette lighter plug at one end and a power jack at the other ([Figure 4-1](#)). The power jack connects to the Tech 2 DLC cable and carries power to the Tech 2 when the selected vehicle adapter does not provide power.

# BATTERY POWER CABLE

This cable has red and black battery clamps attached to one end and a power jack to the other (Figure 4-1). The power jack connects to the Tech 2 DLC cable and carries current to the Tech 2 when the selected vehicle adapter does not provide power and there is no cigarette lighter adapter available.

**NOTE**



This cable contains two 3-amp fuses. If you need to replace them, use identical 3-amp fuses. See [Chapter 6](#) for information on fuse replacement.

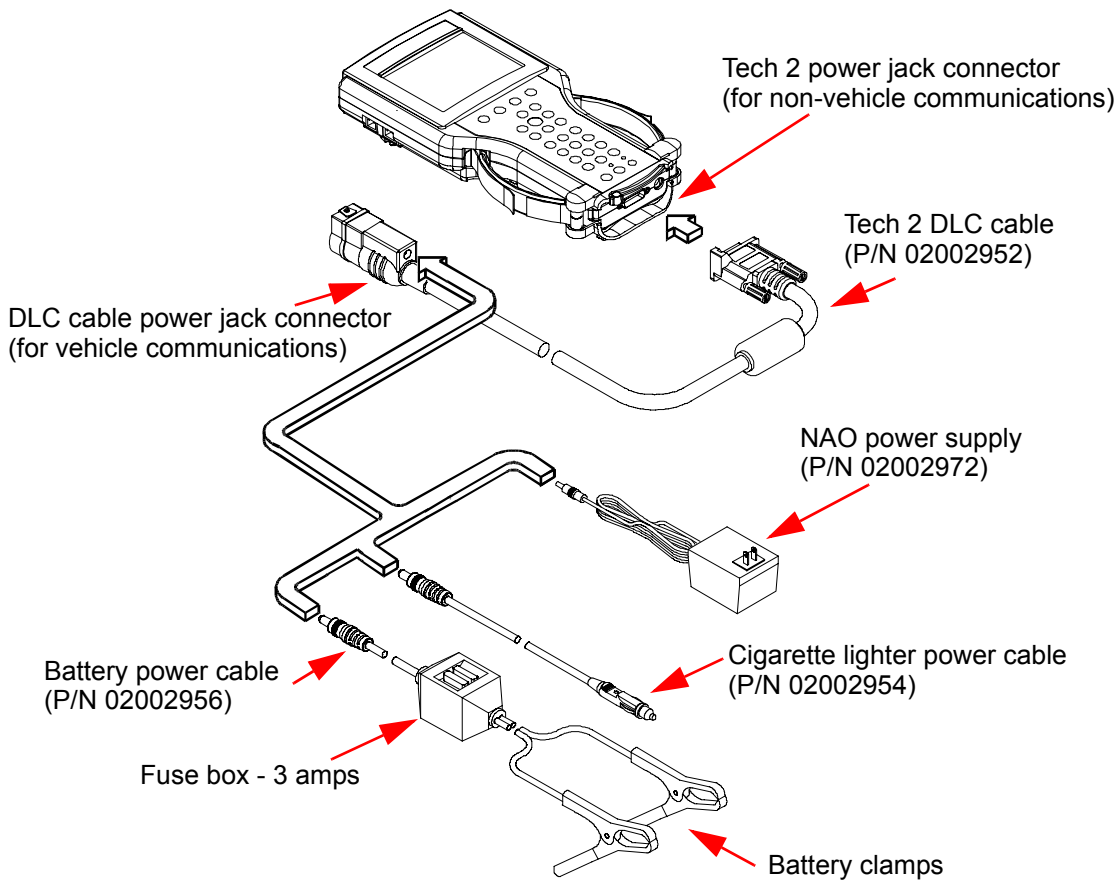

FIGURE 4-1. Tech 2 Power Connections (Without Direct Power Connection from the DLC)

## NAO POWER SUPPLY

North American electrical supply is normally 110 volts. The Tech 2 base kit includes an external AC to DC power supply with 110 V AC/60 Hz input (Figure 4-2). Output is 12 volts at 1.5 amps.

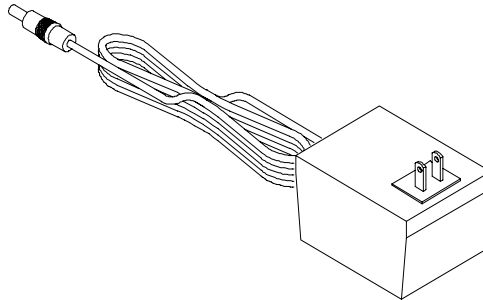

FIGURE 4-2. NAO Power Supply (110 Volts)

### CAUTION!



To avoid personal injury due to electric shock, use a grounded outlet only. The NAO power supply is for North American use only. These devices are intended for indoor use only.



# 5. ADAPTERS

---

A number of adapters are available for the Tech 2 which allow connection to many different vehicles (Table 5-1, *Tech 2 Adapters*). Specific adapters are included in the Tech 2 base kit depending upon Tech 2 configuration—NAO. Adapters not included in the base kit may be purchased separately from Vetronix.

## DLC CABLE

The DLC cable (P/N 02002952) has a 26-pin connector with thumb screws at one end that connects to the Tech 2's VCI cable connector. At the other end is a 19-pin connector that connects to a variety of adapters (Figure 5-1 and Figure 5-2).

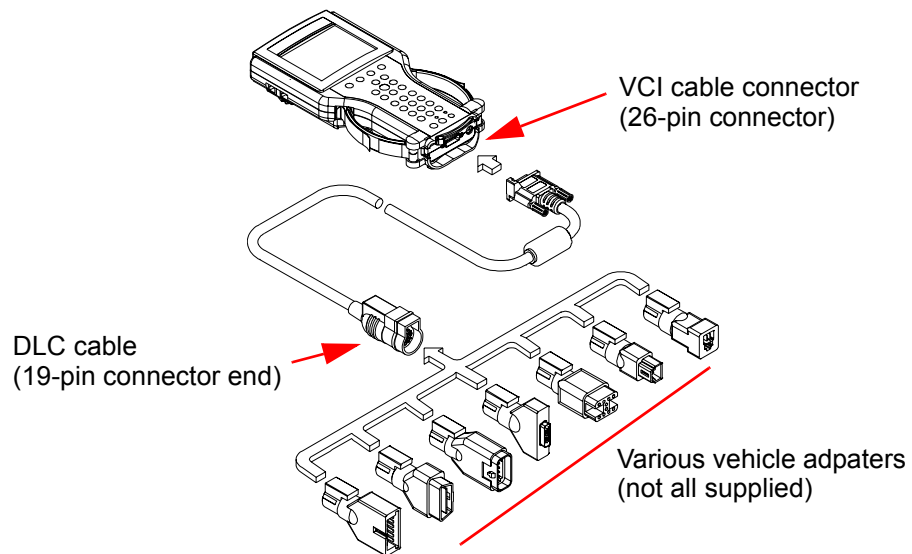

FIGURE 5-1. DLC Cable Adapter Connections

Description	Function	GM Part Numbers
SAE 16/19 Pin Adapter 	This adapter allows DLC connection to some 1994-1995 NAO vehicles and all NAO vehicles from 1996 onward.	02002955
NAO 12/19 Pin Adapter 	This adapter allows ALDL connection to some 1994-1995 NAO vehicles and all previous 1993 and below vehicles equipped with 12-pin ALDL connectors.	02002961

TABLE 5-1. Tech 2 Adapters

## RS-232 CABLE

The RS-232 cable (P/N 02001358) has an 8-pin RJ45 plug connector at each end (Figure 5-2). This cable attaches to the Tech 2 RS-232 port and is used to communicate with a PC.

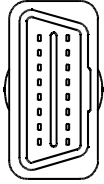
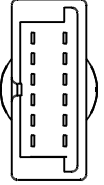
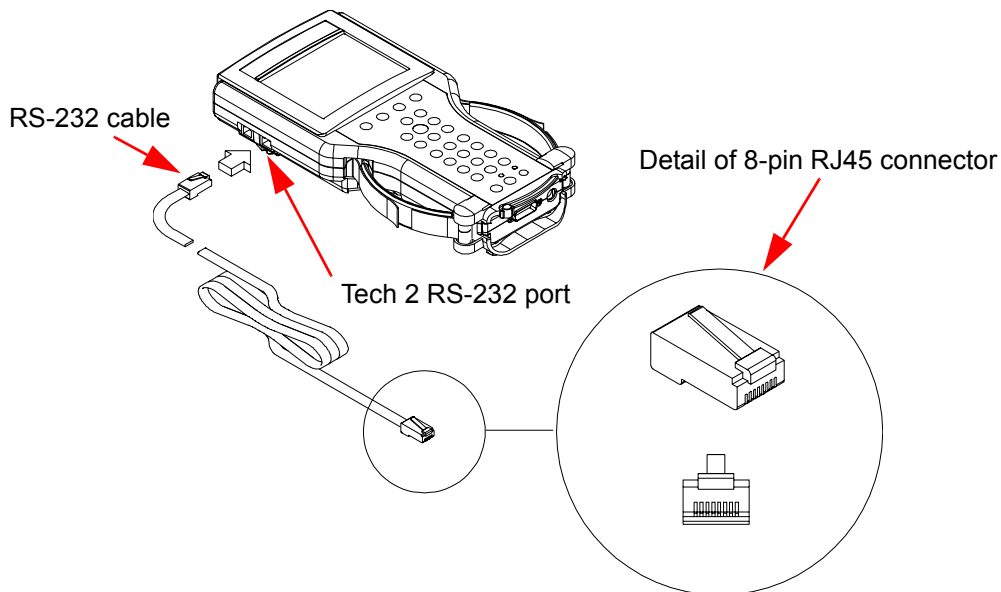

FIGURE 5-2. RS-232 Cable Connections



## RS-232/DB9 ADAPTER

The RJ45/DB9 adapter (P/N 02001030) has an RJ45 connector at one end and a DB9 connector at the other (Figure 5-3). This adapter allows the connection of the Tech 2 to a PC.

## RS-232 LOOPBACK ADAPTER

The loopback adapter (P/N 02001606) has an 8-pin RJ45 connector that attaches to the Tech 2 RS-232 port (Figure 5-3). It is used to perform the Tech 2 self test.

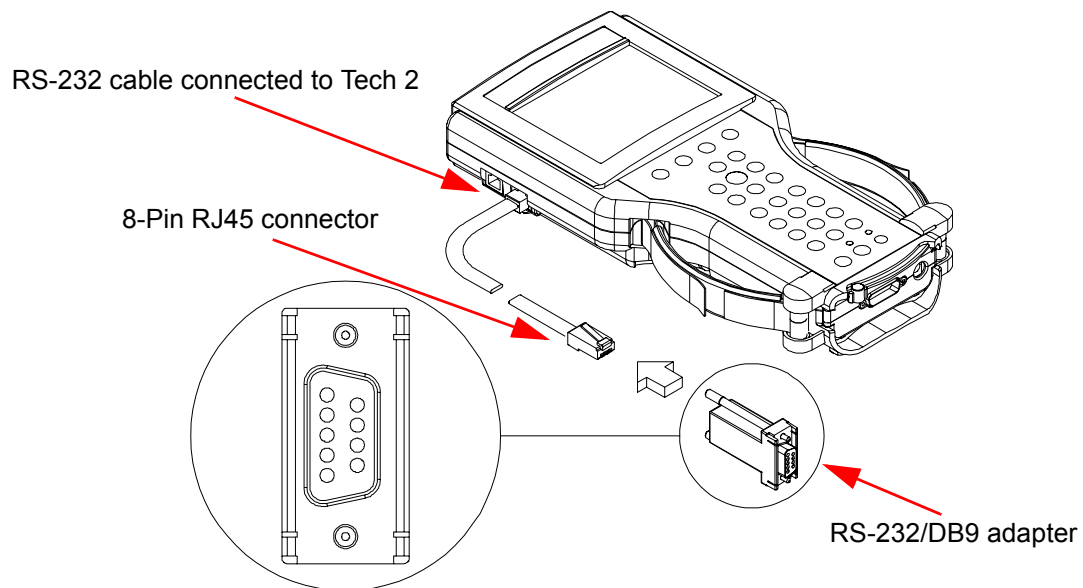

FIGURE 5-3. RS-232/DB9 Adapter Connections



# 6. TROUBLESHOOTING

---

This section is a general troubleshooting guide for all vehicle applications of the Tech 2 scan tool. Some of the information may differ for your particular vehicle application.

When the Tech 2 appears to be operating abnormally, refer to this section for probable causes and solutions.

## **The following two types of self tests are available on the Tech 2:**

- **Power On Self Test (POST)** : checks the major functions of the Tech 2 at power-up.
- **Self Tests** : check the major and minor functions of the Tech 2.

If errors are detected, a Tech 2 malfunction is present which may result in vehicle misdiagnosis. For Customer Support information, refer to the inside cover of this user's guide.

## **POWER ON SELF TEST (POST)**

Power On Self Tests run automatically each time the power [PWR] button on the Tech 2 keypad is pressed on.

**The screen displays pass or fail results for each area tested. POST automatically checks the following:**

- MC68332 processor
- External RAM (Random Access Memory)
- Flash memory
- Display controller and display
- Sound transducer
- MC68332 RAM

- Real-time clock
- Keypad controller and keypad
- Main UART (Universal Asynchronous Receiver/Transmitter)

Results of POST may include fatal errors that do not allow you to continue, or non-fatal errors that allow you to continue without full Tech 2 operation. If normal Tech 2 functions are stopped or limited, contact Customer Support to determine if service is required.

**At completion of POST, the following audible signals indicate a pass or fail condition:**

- One beep - No problem. Your Tech 2 is operating normally.
- No beep - Sound transducer has failed. Contact Customer Support.
- Three short beeps - Tech 2 has failed POST. Contact Customer Support.

## **SELF TESTS**

Tech 2 self tests verify that the Tech 2 is functioning normally. The self tests evaluate all critical areas of the Tech 2 and display pass or fail messages for each subsystem tested. Self tests isolate user error from system hardware failures. The self tests should be performed periodically to insure that the Tech 2 is operating properly.

**The Tech 2 must meet the following requirements in order to do a self test:**

- Screen display must be fully readable
- Keypad must be operational

**Begin the Tech 2 self-testing program by following these steps:**

1. Press **ENTER** while viewing the Tech 2 start-up screen (Figure 6-1).
2. Select **F3: Tool Options** from the Tech 2 main menu (Figure 6-2).
3. Select **F3: Self Test** from the tool options menu (Figure 6-3).



FIGURE 6-1. Tech 2 Start-Up Screen

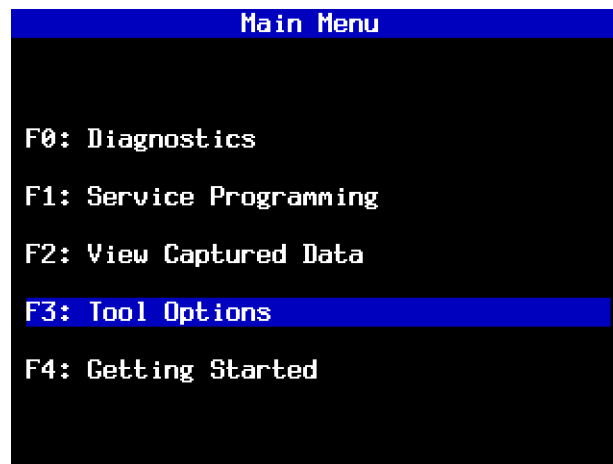

FIGURE 6-2. Tools Options Selected on Main Menu

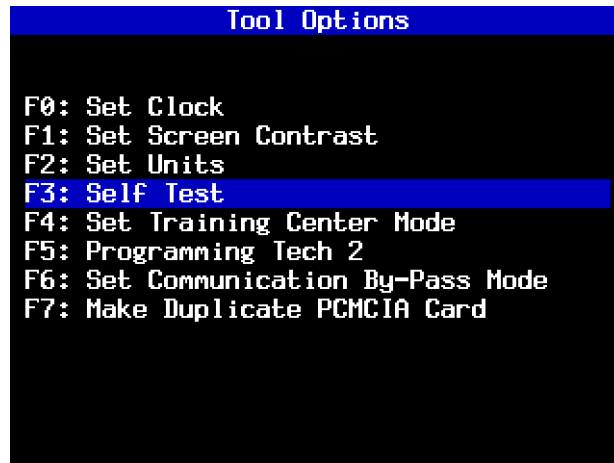

FIGURE 6-3. Self Test Selected on Tool Options Menu

## TECH 2 SELF TEST MAIN MENU

Each Tech 2 Self Test main menu selection is explained in detail on the following pages. All users have access to all the options listed (see [Figure 6-5](#)). Read all screen instructions and connect or disconnect the appropriate cables and loopback adapters. Screen messages display when external loopback connectors are connected. For specific loopback connection information, refer to [Figure 3-2](#), [Figure 3-4](#), and [Figure 6-4](#).

### F0: Automated Main PCB and VCI Test

Selecting Automated Main PCB and VCI ([Figure 6-5](#)) is a quick way to test the performance of the main Printed Circuit Board (main PCB—the Tech 2 main circuit board) and the Vehicle Communications Interface (VCI). The Tech 2 displays a test-in-progress screen ([Figure 6-6](#)) while performing all the PCB and VCI tests in sequential order.

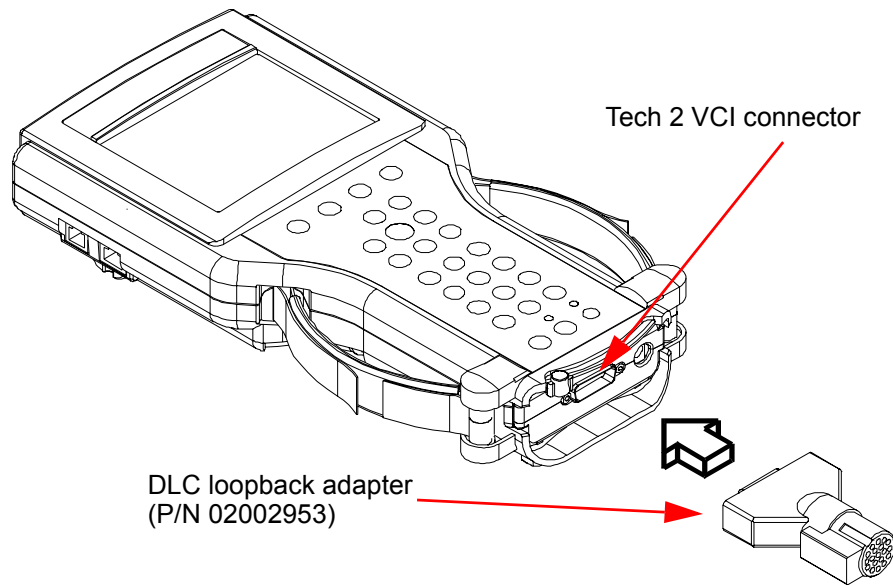

FIGURE 6-4. Connection of DLC Loopback Adapter to the Tech 2 VCI Connector

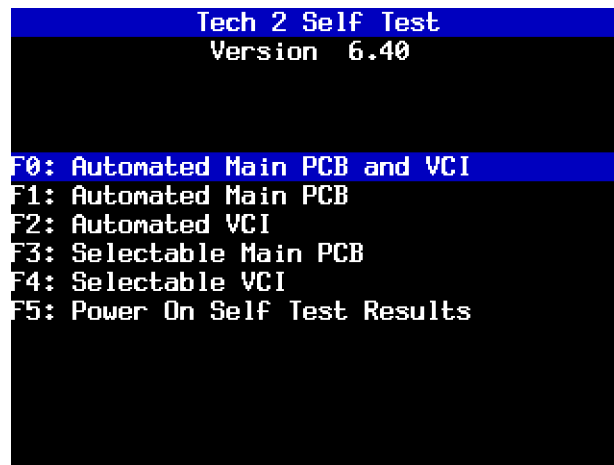

FIGURE 6-5. Tech Automated Main PCB and VCI Test Selected on Tech 2 Self Test Main Menu

**The Automated Main PCB portion tests the following components:**

- RAM / ROM
- RS-485 loopback \*
- RS-232 loopback \*
- Keypad
- PCMCIA slot 1

\*. Each of these tests requires the connection of a loopback adapter to the Tech 2.

- PCMCIA slot 2
- Display controller
- Sound transducer
- Real-time clock

Refer to [Table 6-1](#) and [Table 6-2](#) for help in diagnosing problems that involve the Tech 2's PCB and VCI.

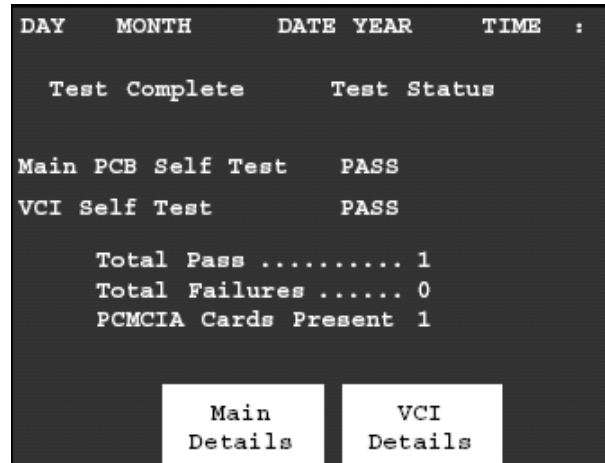

FIGURE 6-6. Automated Main PCB and VCI Test Results Screen

If the Tech 2 passes all Automated Main PCB and VCI tests, you do not need to run any more tests to verify that the Tech 2 is working properly.

The following test results are displayed:

Total Pass	1 - indicates that Tech 2 passed test 0 - indicates a test failure
Total Failures	0 - indicates that Tech 2 passed test 1 - indicates a test failure
PCMCIA Cards Present	1 or 2 indicates how many cards present in Tech 2

Once tests are complete, select the soft keys Main Details or VCI Details ([Figure 6-6](#)) to review the results of the main PCB or VCI tests (see [Figure 6-7](#) and [Figure 6-8](#)).

If any failures occur, select **F3: Selectable Main PCB** ([Figure 6-11](#)) or **F4: Selectable VCI** ([Figure 6-13](#)) from the Tech 2 Self Test main menu to further isolate the failure. Report failure information to Customer Support.



```

DAY      MONTH      DATE YEAR      TIME  :

Test Complete          Test Status
RAM / ROM ..... Pass
RS-485 ..... Missing LoopBack
RS-232 ..... Pass
Keypad ..... Pass
PCMCIA Slot 1 ..... Pass
PCMCIA Slot 2 ..... Card Not Present
Display ..... Pass
Sound Transducer .... Pass
Real-Time Clock ..... Pass
    
```

FIGURE 6-7. Main Details Selection

```

DAY      MONTH      DATE YEAR      TIME  :

Test Complete
MUX ..... Pass      ADC ..... Pass
SIPO 8 ... Pass      SIPO 20 ... Pass
DLC 1 ... Pass       DLC 2 ..... Pass
TPU ..... Pass      HBCC ..... Pass
CCD ..... Pass      Dual Uart . Pass
J1708 ..... Pass     Gnd FET ... Pass

Level Shifters .... Pass
Cross Point ..... Pass
Short L and M ..... Pass
Test I/01-I/016 ... Pass
LoopBack ..... Pass
    
```

FIGURE 6-8. VCI Details Selection

Test	Results	Solution
RAM/ROM	0-Pass 1-ROM read fail 2-RAM read fail 3-RAM write and read do not compare	Record type of failure. Cycle Tech 2 power (press [PWR]) and retest. If problem persists, contact Customer Support.
RS-485 loopback	Pass Fail-Loopback may not be connected	Check loopback connection. If problem persists, contact Customer Support.
RS-232 loopback	Pass Fail-Loopback may not be connected	Check loopback connection. If problem persists, contact Customer Support.
Keypad	Test successful Keypad failed Exiting test before all keys are pressed results in a failed keypad test	Cycle Tech 2 power and retest. If problem persists, contact Customer Support.
PCMCIA (tests both card slots)	Card detected Card not present Fail	Check that card is inserted properly. Cycle Tech 2 power and retest. If problem persists, contact Customer Support.
Display controller (contrast and characters)	User determines if display is correct.	If the display shows a noticeable failure during tests, contact Customer Support.
Sound transducer	User determines if sound transducer is working.	If no sound is emitted by repeatedly selecting Automated Test or Sound On, contact Customer Support.
Real-time clock	Time is displayed correctly. Invalid values are displayed for date, year, hour, minute, or second.	Reset clock. Cycle Tech 2 power and retest. If time is not retained, contact Customer Support.

TABLE 6-1. PCB Diagnostic Chart

Test	Results	Solution
MUX (Multiplexer)	MUX A: S5 & S14 pass/fail MUX B: S1 & S3 pass/fail	If MUX A or B fails, cycle Tech 2 power and retest. If problem persists, contact Customer Support.
VCI adapter ID (performed only during selectable VCI test)	Recognized adapter Cannot identify adapter	If adapter fails, use a different adapter to make sure that the VCI correctly identifies the adapters. Cycle Tech 2 power and retest failed adapter. If adapter fails second test, contact Customer Support.
VCI ADC (Analog to digital converter)	Channel A - pass/fail Channel B - pass/fail	If channel A or B fails, cycle Tech 2 and retest. If problem persists, contact Customer Support.
Cross point	Pull up - pass/fail TPU5, TPU1, and TPU0 - pass/fail (results from selectable VCI test)	If a failure occurs, cycle Tech 2 and retest. If problem persists, contact Customer Support.

TABLE 6-2. VCI Module Diagnostic Chart

Test	Results	Solution
SIPO (Serial In Parallel Out)	Pass/fail for each area tested	If a failure occurs, cycle Tech 2 and retest. If problem persists, contact Customer Support.
DLC (Data Link Connector)	DLC1 - DLC2 pass/fail count DLC2 - DLC1 pass/fail count	If a failure occurs, cycle Tech 2 and retest. If problem persists, contact Customer Support.
CCD (Chrysler Collision Detection)	CCD - pass/fail CCD - loopback not connected	Connect loopback and retest if loopback not connected. If test fails, disregard results. Test is not for GM vehicles (other than Saab) at this time.
GND FET (Ground Field Effect Transistor)	GND FET - pass/fail	Check loopback adapter to make sure it is connected, cycle Tech 2 retest. If problem persists, contact Customer Support.
VCI HBCC (Hosted Bus Control Chip)	HBCC - pass/fail	If HBCC chip fails, cycle Tech 2 and retest. If problem persists, contact Customer Support.
VCI DUART (Dual Universal Asynchronous Receiver Transmitter)	Channel A - pass/fail Channel B - pass/fail	If channel A or B fails, cycle Tech 2 and retest. If problem persists, contact Customer Support.
VCI I/O 1 - I/O 16 Test	Pass/fail messages displayed for each of the I/O lines (results from selectable VCI test).	If test fails, was loopback installed? Once an error has been detected on one of the I/O lines, you can test the specific line by selecting F3 or F4 tests. If the test fails continuously or intermittently, contact Customer Support.
VCI loopback	Pass/fail message for each I/O loopback test.	For any failure, make sure the loopback is connected. Use F:1 Check ID to verify that the loopback is found. Cycle Tech 2 and retest. If problem persists, contact Customer Support.
VCI short L & M	Open I/O 7 - pass/fail Open I/O 9 - pass/fail Hi I/O 7 - pass/fail Hi I/O 9 - pass/fail Lo I/O 7 - pass/fail Lo I/O 9 - pass/fail	For any failure, cycle Tech 2 and retest. If problem persists, contact Customer Support.
VCI J1708	Internal transceiver - pass/fail Differential - pass/fail Differential - pass/fail (results from selectable VCI test)	For any failure, cycle Tech 2 and retest. If problem persists, contact Customer Support.

TABLE 6-2. VCI Module Diagnostic Chart (Continued)

Test	Results	Solution
VCI TPU (Time Processor Unit)	TPU0 - pass/fail TPU1 - pass/fail TPU5 - pass/fail TPU12 & TPU15 - pass/fail (or not tested if no loopback) TPU13 & TPU14 - pass/fail (or not tested if no loopback)	For any failure, cycle Tech 2 and retest. If problem persists, contact Customer Support.
VCI level shifters	MUX A 2.5 V Hi - pass/fail MUX A 2.5 V Lo - pass/fail MUX A 5.0 V Hi - pass/fail MUX A 5.0 V Lo - pass/fail (results from selectable VCI test)	For any failure, cycle Tech 2 and retest. If problem persists, contact Customer Support.

TABLE 6-2. VCI Module Diagnostic Chart (Continued)

### F1: Automated Main PCB Test

This test works the same as the Automated Main PCB and VCI test, except the VCI portion of the test is not included (Figure 6-9).

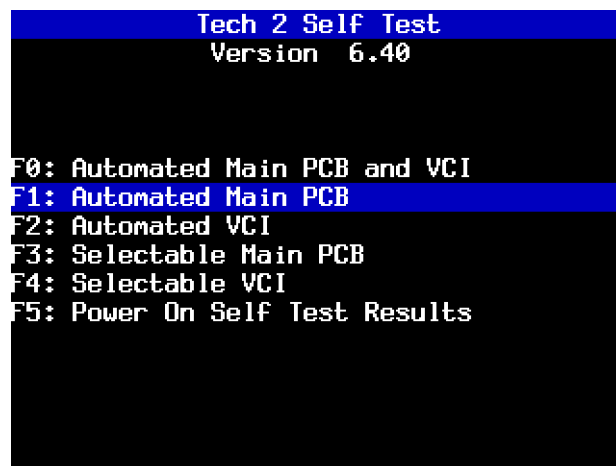

FIGURE 6-9. Automated Main PCB Test Selected on Tech 2 Self Test Main Menu

## F2: Automated VCI Test

This test works the same as the Automated Main PCB and VCI test, except the PCB portion of the test is not included (Figure 6-10).



FIGURE 6-10. Automated VCI Test Selected on Tech 2 Self Test Main Menu

### F3: Selectable Main PCB Test

Select **F3: Selectable Main PCB** (Figure 6-11) after a fail message has been displayed during the Automated Main PCB and VCI or Automated Main PCB tests. When you select **F3: Selectable Main PCB**, a screen like the one shown in Figure 6-12 is displayed. You may then select individual tests for failed components. For specific information on failed components, refer to the Main Printed Circuit Board (PCB) Diagnostic Chart (Table 6-1, *PCB Diagnostic Chart*, on page 6-8).

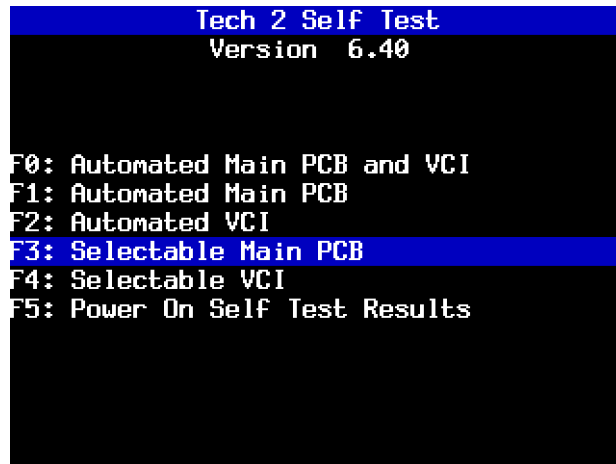

FIGURE 6-11. Selectable Main PCB Test Selected on Tech 2 Self Test Main Menu

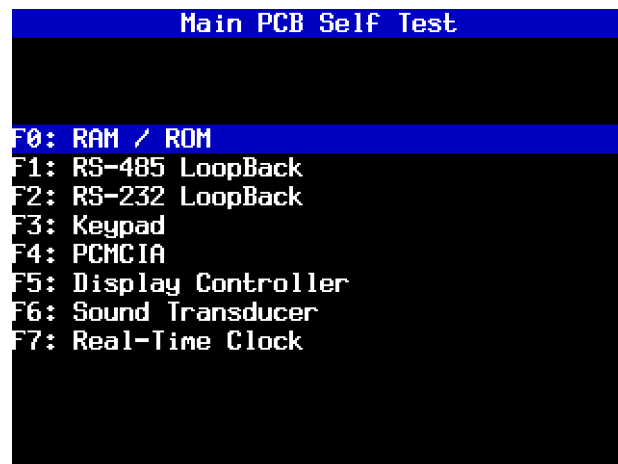

FIGURE 6-12. Selectable Main PCB Self Test Screen

## F4: Selectable VCI Test

Select F4: Selectable VCI (Figure 6-13) after a fail message displays during the Automated Main PCB and VCI or Automated VCI tests. When you select F4: Selectable VCI, a screen like the one shown in Figure 6-14 is displayed. You may select individual tests for failed components from this screen. If you select More Tests, a screen like the one shown in Figure 6-15 is displayed. If you then select Previous Menu, the screen shown in Figure 6-14 returns. For specific information on failed components, refer to the Vehicle Communications Interface (VCI) Module Diagnostic Chart (Table 6-2, *VCI Module Diagnostic Chart*, on page 6-8).

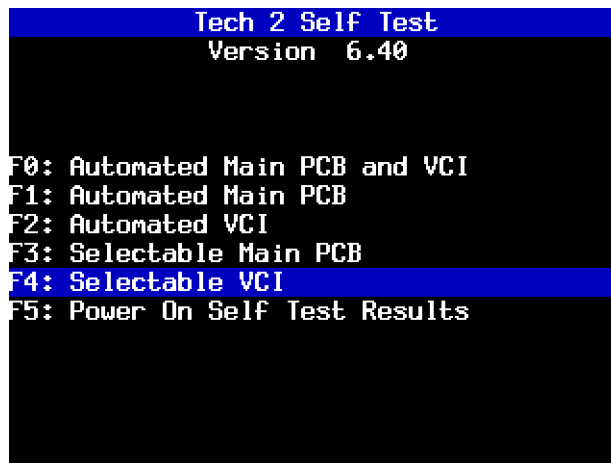

FIGURE 6-13. Selectable VCI Test Selected on Tech 2 Self Test Main Menu

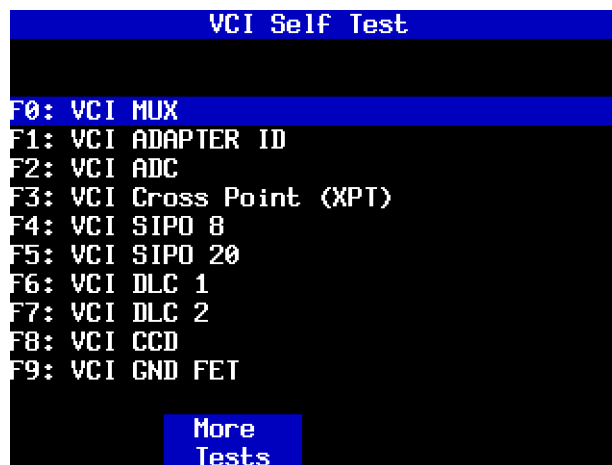

FIGURE 6-14. First Selectable VCI Self Test Screen

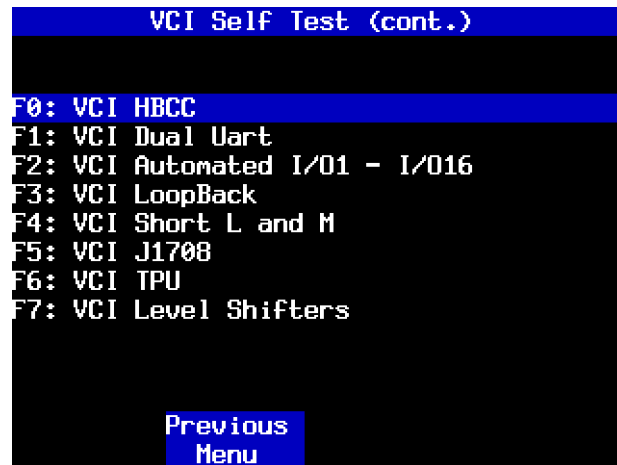

FIGURE 6-15. Second Selectable VCI Self Test Screen



## F5: Power On Self Test Results

Select **F5: Power On Self Test Results** (Figure 6-16) after a fail message displays during the Power On Self Test (POST). Specific information on the failure displays on the screen. Select F0, F1, F2, F3, or F4 to further isolate the specific fault.

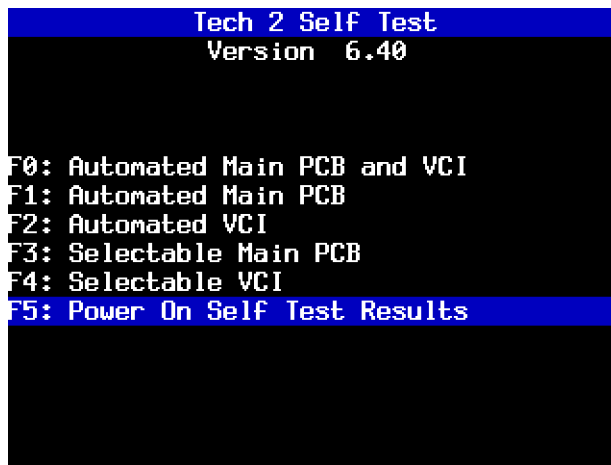

FIGURE 6-16. Power On Self Test Results Selected on Tech 2 Self Test Main Menu

## NO POWER TO TECH 2 TROUBLESHOOTING TABLES

Use the following tables to diagnose, isolate, and correct power source problems that may cause a No Power condition to your Tech 2 scan tool.

To help determine the power supply source, see [Chapter 4](#).

Power Source: DLC Cable			
Step	Action	Yes	No
1	Does vehicle support power through DLC cable connection exclusively? (If you are not sure, consult your service manual.)	Go to Step 2.	Use alternate power.
2	<ul style="list-style-type: none"> <li>Using a digital multi-meter (DMM), verify vehicle battery voltage.</li> </ul> Is battery fully charged?	Go to Step 3.	Charge battery.
3	<ul style="list-style-type: none"> <li>Verify connection at vehicle DLC connector for loose or damaged pin(s).</li> </ul> Did you find a problem?	Repair connector. (Consult vehicle service manual.)	Go to Step 4.
4	<ul style="list-style-type: none"> <li>Disconnect DLC cable from vehicle.</li> <li>Power on Tech 2 using alternate power source at DLC cable power jack connection.</li> </ul> Did your Tech 2 power on?	Problem with vehicle. (Consult vehicle service manual.)	Go to Step 5.
5	<ul style="list-style-type: none"> <li>Remove DLC cable from Tech 2 and attach alternate power supply at VCI power jack connection located at the bottom of Tech 2.</li> </ul> Does Tech 2 power on?	Replace DLC cable.	Problem with Tech 2. Contact Customer Support.

TABLE 6-3. DLC Cable No Power Troubleshooting Table

<b>Power Source: Cigarette Lighter Power Cable</b>			
<b>Step</b>	<b>Action</b>	<b>Yes</b>	<b>No</b>
1	<ul style="list-style-type: none"> <li>• Unplug cigarette lighter power cable from DLC cable.</li> <li>• Using a digital multi-meter (DMM), verify voltage output at cigarette lighter power cable power jack.</li> </ul> Do you have battery voltage output?	Go to Step 3.	Go to Step 2.
2	<ul style="list-style-type: none"> <li>• Check fuse in cigarette lighter power cable (refer to <a href="#">Figure 6-17</a>).</li> </ul> Does fuse need replacing?	Replace fuse.	Go to step 3.
3	<ul style="list-style-type: none"> <li>• Remove DLC cable from Tech 2.</li> <li>• Plug in cigarette lighter power jack to the VCI power jack connector located at bottom of Tech 2.</li> </ul> Does the Tech 2 power on?	Replace DLC cable.	Problem with Tech 2. Contact Customer Support.
4	<ul style="list-style-type: none"> <li>• Using a DMM, verify voltage output at battery.</li> </ul> Do you have battery voltage output?	Go to Step 5.	Charge battery.
5	<ul style="list-style-type: none"> <li>• Disconnect cigarette lighter power cable from vehicle and verify voltage output at vehicle cigarette lighter socket.</li> </ul> Do you have battery voltage output?	Replace cigarette lighter power cable.	Problem with vehicle. Consult vehicle service manual.

TABLE 6-4. Cigarette Lighter Power Cable No Power Troubleshooting Table

Power Source: Battery Power Cable			
Step	Action	Yes	No
1	<ul style="list-style-type: none"> <li>• Unplug battery power cable power jack from DLC cable.</li> <li>• Using a digital multi-meter (DMM), verify voltage output at battery power cable power jack.</li> </ul> Do you have battery voltage output?	Go to Step 3.	Go to Step 2.
2	<ul style="list-style-type: none"> <li>• Check fuse(s) in battery power cable (refer to <a href="#">Figure 6-18</a>).</li> </ul> Does fuse(s) need replacing?	Replace fuse(s).	Go to Step 3.
3	<ul style="list-style-type: none"> <li>• Remove DLC cable from Tech 2.</li> <li>• Plug in battery power cable power jack to the VCI power jack connector located at bottom of Tech 2.</li> </ul> Does the Tech 2 power on?	Replace DLC cable.	Problem with Tech 2. Contact Customer Support.
4	<ul style="list-style-type: none"> <li>• Using a DMM, verify voltage output at battery.</li> </ul> Do you have battery voltage output?	Replace battery power cable.	Charge battery.

TABLE 6-5. Battery Power Cable No Power Troubleshooting Table

Power Source: Battery Power Cable			
Step	Action	Yes	No
1	<ul style="list-style-type: none"> <li>• Unplug NAO (or Universal) power supply power jack from DLC cable.</li> <li>• Using a digital multi-meter (DMM), verify voltage output at power jack.</li> </ul> Do you have battery voltage output?	Go to Step 2.	Replace NAO or Universal power supply.
2	<ul style="list-style-type: none"> <li>• Remove DLC cable from Tech 2.</li> <li>• Plug in NAO (or Universal) power supply power jack to the VCI power jack connector located at bottom of Tech 2.</li> </ul> Does the Tech 2 power on?	Replace DLC cable.	Problem with Tech 2. Contact Customer Support.

TABLE 6-6. NAO or Universal No Power Troubleshooting Table

## CIGARETTE LIGHTER POWER CABLE 3-AMP FUSE REPLACEMENT

A three-amp removable fuse is located in the cigarette lighter power cable (P/N 02002954) connector.

**When required, check or replace the fuse by performing the following steps:**

1. Ensure the cigarette lighter power cable is not connected to the vehicle or Tech 2.
2. Unscrew the fuse retainer cap and remove the 3-amp fuse.
3. Inspect the fuse for damage and replace it with an identical 3-amp fuse if required.
4. Verify by connecting the cigarette lighter power cable to the Tech 2 and vehicle.

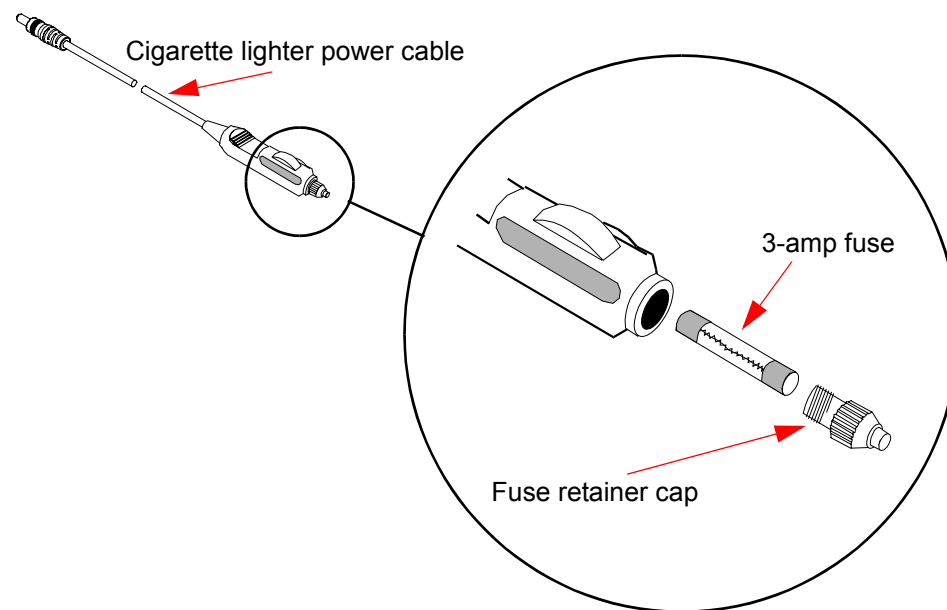

FIGURE 6-17. Cigarette Lighter Power Cable 3-Amp Fuse Replacement

## BATTERY POWER CABLE 3-AMP FUSE REPLACEMENT

Two three-amp fuses are located in the battery power cable (P/N 02002956) three-amp fuse box.

**When required, check or replace the fuse(s) by following the steps below.**

### CAUTION!



To help avoid personal injury by electric shock, make sure the battery power cable is not connected to the vehicle's battery before removing the fuse(s).

1. Ensure the battery power cable is not connected to the vehicle battery or Tech 2.
2. Use a standard fuse puller to remove the fuse(s) from the fuse box.
3. Inspect the fuse(s) for damage and replace with identical 3-amp fuse(s) if required.
4. Verify by connecting the battery power cable to the Tech 2 and vehicle battery.

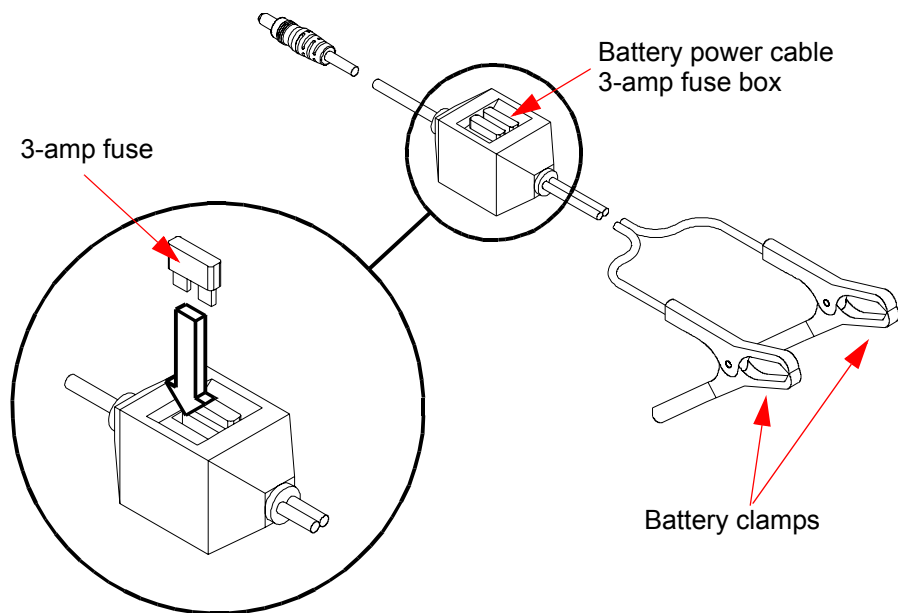

FIGURE 6-18. Battery Power Cable 3-Amp Fuse Replacement

---

# TECHNICIAN NOTES

Lined area for technician notes, consisting of 25 horizontal dashed lines.





# 7. ABBREVIATIONS

TERM	DEFINITION
3GR	third gear
4GR	fourth gear
4WAL	four-wheel antilock
4WD	four-wheel drive
AAT	ambient air temperature
ABS	antilock brake system
A/C	air conditioning
accel	acceleration
accum	accumulator
accy	accessory
ACL	air cleaner
ACM	air conditioning module
act	actual
actv	activate
A/D	analog to digital
AD	accommodated device
adapt	adaptive
adapts	adapters
ADG	accommodated device gateway
adj	adjust

TERM	DEFINITION
ADL	automatic door lock
ADS	auxiliary discriminating sensor
A/F	air/fuel ratio
aft	after
ahrs	amp hours
AIR	secondary air injection
ALC	automatic lamp control automatic level control
ALDL	assembly line diagnostic link
ALM	automatic level module
AM	amplitude modulation
amp	amplifier
amps	amperages
APP	accelerator pedal position
Apr	April
ARS	adaptive receptive system
asm	assembly
ASR	acceleration slip regulation
A/T	automatic transmission
ATC	active transfer case automatic transfer case

TERM	DEFINITION
ATF	automatic transmission fluid
Aug	August
auto	automatic
aux	auxiliary
avg	average
AWD	all-wheel drive
B+	battery positive voltage
BARO	barometric pressure
batt	battery
BBV	brake booster vacuum
BCM	body control module
BFC	body function controller
blts	belts
BLW	brake lining wear
bn	bank
BPCM	battery pack control module
BPMV	brake pressure modulator valve
BTCM	brake torque control module
BTSI	brake transmission shift interlock
cal	calibration
calc	calculated
CAN	controller area network
CASE	crankshaft angle sense error
cass	cassette
CC	climate control
CCM	central control module
CCW	counter clockwise
CD	compact disc
CDX	compact disc changer
CKP	crankshaft position
CKT	circuit
CL	closed loop

TERM	DEFINITION
cm	centimeter
cmd	command
cmmd	commanded
CMP	camshaft position
CNG	compressed natural gas
CO	carbon monoxide
CO2	carbon dioxide
combo	combination
comm	communication
compl	complete(d)
cond	condition
config	configuration
const	constant
COP	computer operating properly
CPP	clutch pedal position
CPS	childseat positioning sensor
CTP	closed throttle position
ctrl	control
ctsy	courtesy
CVRSS	continuously variable road sensing suspension
CVRTD	continuously variable real time damping
cyl	cylinder
DAB	delayed accessory bus
dB	decibels
dBm	decibel meter
DC	duty cycle
DCM	door control module
DDM	driver door module
DDS	driver door switch
Dec	December
dec	decrement

TERM	DEFINITION
decel	decelerate
def	defrost
defog	defogger
deg	degrees
deg C	degrees Celsius
del	delivered
DERM	diagnostic energy reserve module
des	desired
desc	description
DI	distributor ignition
diag	diagnostic
DIC	driver information center
diff	differential
dig	digit
DIM	dash integration module
dis	disable
discon	disconnect
discrim	discriminate
disp	display
DLC	data link connector
DMCM	drive motor control module
DMM	digital multimeter
DNR	Dolby noise reduction
DOHC	dual overhead cam
dol	Dolby
dr	door
DRL	daytime running lights
DRP	dynamic rear proportion
drv	driver
DSM	driver seat module
DSP	digital signal process
DTC	diagnostic trouble code

TERM	DEFINITION
dwn	down
E&C	entertainment and comfort
EBCM	electronic brake control module
EBM	electronic brake module
EBTCM	electronic brake and traction control module
EC	engine control
ECC	electronic climate control
ECL	engine coolant level
ECM	electronic control module engine control module
econ	economy
ECT	engine coolant temperature
ECU	electronic control unit
EEPROM	electrically erasable programmable read-only memory
EGR	exhaust gas recirculation
EHC	electric hydraulic control unit
EI	electronic ignition
elec	electric
EMB	electromagnetic brake
enab	enabled
eng	engine
EOP	engine oil pressure
EOT	engine oil temperature
EQ	equalizer
ESB	expansion spring brake
ESC	electronic suspension control
ESD	electrostatic discharge
EST	electronic spark timing
est	estimated
ETC	electronic temperature control electronic throttle control electronic timing control
ETS	enhanced traction system

TERM	DEFINITION
EV	electric vehicle
EVAP	evaporative emission
evap	evaporator
EVO	electronic variable orifice
ext	extended
F	Fahrenheit
F4WD	full-time four-wheel drive
FC	fan control
fdbk	feedback
Feb	February
FEDS	fuel enable data stream
FEIC	fuel economy integrated counter
FET	field effect transistor
filt	filter
FL	front left
flr	floor
FM	frequency modulation
FP	fuel pump
FR	front right
freq	frequency
frnt	front
FT	fuel trim
ft-lb	foot-pounds
fwd	forward
FWD	front-wheel drive
g/cyl	grams per cylinder
GEN	generator
GND	ground
GPS	global positioning system
GVW	gross vehicle weight
HC	hydrocarbon(s)
HCM	heating control module

TERM	DEFINITION
HD	heavy duty
hex	hexadecimal
HI	high
hist	history
HO2S	heated oxygen sensor
horiz	horizontal
hr	hour
hrs	hours
HTCM	HVAC thermal control module
htr	heater
HUD	head-up display
HVAC	heating ventilation air conditioning
H/W	hardware
HW	heated windshield
hz	hertz
IAC	idle air control
IAT	intake air temperature
IC	ignition control
ICCS	integrated chassis control system
ICM	ignition control module
ICS	integrated chassis system
ID	identification
ign	ignition
illum	illumination
immo	immobilizer
in	inch(es)
inadv	inadvertent
inc	increment
incand	incandescent
infl	inflatable
info	information
init	initial

TERM	DEFINITION
inj	injector
inst	instant
int	interior
I/O	in/out
I/P	instrument panel
IPC	instrument panel cluster
IPM	instrument panel module
IRQ	interrupt request
ISC	idle speed control
iso	isolation
ISS	input shaft speed
Jan	January
Jul	July
Jun	June
KAM	keep alive memory
KDD	keyboard display driver
kg/h	kilograms per hour
km	kilometer
km/h	kilometers per hour
km/l	kilometers per liter
kpa	kilopascal
KS	knock sensor
LCD	liquid crystal display
LCM	lighting control module
LDCL	left door close locking
LDCM	left door control module
lduty	light duty
LED	light emitting diode
LF	left front
LFWS	left front wheel speed
LGM	lift gate module
LH	left hand

TERM	DEFINITION
LMD	left mid door
LO	low
LPS	low pressure sensor
L/R	left/right
LR	left rear
LRD	left rear door
lrn	learn
LTPWS	low tire pressure warning system
lvl	level
MAF	mass airflow
malf	malfunction
MALL	multifunction alarm lighting and locking
man	manual
manufact	manufactures
MAP	manifold absolute pressure
Mar	March
MAT	manifold air temperature
max	maximum
MCU	microprocessor control unit
MD	mini disk
med	medium
mem	memory
MFI	multiport fuel injection
mgmt	management
mid	midrange
MIL	malfunction indicator lamp
min	minute(s)
mm <sup>3</sup>	cubic millimeters
mmhg	millimeters of mercury
MMM	memory mirror module
mod	module
mon	monitor

TERM	DEFINITION
mpg	miles per gallon
mph	miles per hour
msg	message
MSM	memory seat module
MSVA	magnetic steering variable assist
mtr	motor
mult	multiple
mux	multiplex
nav	navigation
NDH	navigation display head
NGO	natural gas operation
no	number
Nov	November
NOx	nitrogen oxides
NVRAM	non-volatile random access memory
O2	oxygen
O2S	oxygen sensor
OAT	outside air temperature
OBD	on-board diagnostic
OBPA	off-board programming adapter
Oct	October
OEM	original equipment manufacturer
orig	original
OSC	oxygen storage capacity
OSS	output shaft speed
parms	parameters
PC	pressure control (solenoid valve)
PCB	printed circuit board
PCM	powertrain control module
PCMCIA	personal computer memory card industry association
PCS	pressure control solenoid
PCV	positive crankcase ventilation

TERM	DEFINITION
PDIF	pressure differential
PDM	passenger door module
PDS	passenger door switch
PEB	power electronics bay
perf	performance
phn	phone
PID	parameter identification
PLL	phase locked loop
PMV	pressure modulator valve
PNP	park/neutral position
pos	position
PPS	passenger presence sensing
press	pressure
preten	pretensioner
prev	previous
prim	primary
prog	program
PROM	programmable read-only memory
PS	power steering
PSCM	passenger seat control module
psgr	passenger
psi	pounds per square inch
PSIR	passenger supplemental inflatable restraint
PSP	power steering pressure
PWM	pulse width modulation
pwr	power
PZM	platform zone module
QDM	quad driver module
R/A	resume or accelerate
RAC	remote accessory controller
RAM	random access memory
ran	random

TERM	DEFINITION
RAP	retained accessory power
RCC	rear climate control
RDCM	right door control module
RDM	rear door module
RDS	radio display system
rec	receive
recal	recalibrate, recalibration
recep	receptacle
recirc	recirculation
recl	recline
ref	reference
refrig	refrigeration
regen	regenerate
req	request
resist	resistance
resync	resynchronize
rev	reverse
RF	radio frequency right front
RFA	remote function actuator
RFI	radio frequency interference
RFWS	right front wheel speed
RH	right hand
RIM	radio interface module rear integration module
RKE	remote keyless entry
R/L	right/left
RMD	right mid door
ROM	read-only memory
RPM	revolutions per minute
RPO	regular production option
RR	right rear
RRD	right rear door

TERM	DEFINITION
RSS	road sensing suspension
rt	right
RTC	real-time clock
RTD	real-time damping
RTT	reconfigurable telltale
RWD	rear-wheel drive
SBM	standard body module
SC	supercharger
SCV	speed controlled volume
SDL	serial data link
SDM	sensing and diagnostic module
sec	second(s)
sen	sensor
Sep	September
seq	sequence
ser	serial
SFI	sequential fuel injection
sig	signal
SIR	supplemental inflatable restraint
SIS	side impact sensor
SMCC	stepper motor cruise control
SOH	state of health
sol	solenoid
spd	speed
speedo	speedometer
SPI	serial peripheral interface
SPS	service programming system speed signal
SS	shift solenoid
SSS	speed sensitive steering
SSV	shift solenoid valve
stdby	standby
STL	service transmission lamp

TERM	DEFINITION
S/W	software
sw	switch
Switz	Switzerland
SWPS	steering wheel position sensor
SXR	serial transmit and receive
sync	synchronize
sys	system
TAC	throttle actuator control
tach	tachometer
TAP	throttle adaptive pressure transmission adaptive pressure
TBC	truck body controller
TBI	throttle body fuel injection
TC	turbocharger
TCC	torque converter clutch
TCM	transmission control module
TCS	traction control system
TDC	top dead center
tele	telescope
temp	temperature
TFP	transmission fluid pressure
TFT	transmission fluid temperature
TIM	tire inflation monitor
TIS	Techline information system
torq	torque
TP	throttle position
TPM	tire pressure monitor
TR	transmission range
trac	traction
trans	transmission
transp	transponder
trk	truck
TSS	turbine shaft speed

TERM	DEFINITION
TT	telltale lamp
TTM	tilt and telescope module
TVV	thermal vacuum valve
TWC	three-way catalytic converter
twtr	tweeter
UART	universal asynchronous receiver transmitter
unlk	unlock
vac	vacuum
VATS	vehicle anti-theft system
VCI	vehicle communications interface
VCM	vehicle control module
VDR	vehicle dealer recorder
veh	vehicle
ver	version
vert	vertical
VES	variable effort steering
VF	vacuum fluorescent
VICS	vehicle information communication system
VIN	vehicle identification number
vlv	valve
VR	voltage regulator
vspd	vehicle speed
VSS	vehicle speed sensor
VSV	vacuum solenoid valve
VTD	vehicle theft deterrent
warn	warning
w/o	without
WOT	wide open throttle
xpress	express



# 8. SOFTWARE

---

This section contains a description of Tech 2 software, based on the latest product information available at the time of publication. Tech 2 flowcharts are provided on the following pages to give you an overview of the many Tech 2 software options.

The section continues with a look at *Tool Options* on [page 8-6](#) and *Getting Started* on [page 8-13](#) to familiarize you with the various tool settings and to provide you with useful operation information. Next, you can see how to use *Techline Information System 2000 (TIS 2000)* on [page 8-15](#) to perform service programming, Tech 2 updates, and snapshot procedures. Finally, comprehensive *Tech 2 Pathing Tables* on [page 8-43](#) help you navigate to specific special functions that the Tech 2 offers.

## NOTE



Proper PCMCIA updates are essential for successful vehicle diagnoses. Refer to function *F5: Programming Tech 2* on [page 8-11](#) and *PCMCIA Card* on [page 8-26](#).

## TECH 2 FLOWCHART

Five basic functions or “paths” are available on the Tech 2's Main Menu: Diagnostics, Service Programming, View Captured Data, Tool Options, and Getting Started (see [Figure 6-2](#)).

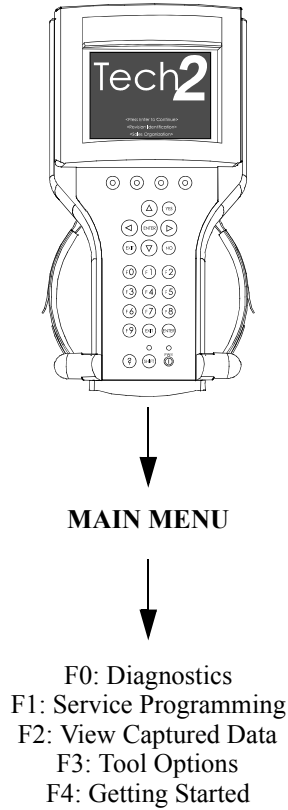

FIGURE 8-1. The Tech 2's Five Basic Functions or “Paths”

## DIAGNOSTICS

[Table 8-1](#) shows the flow to the four major areas within Diagnostics: Powertrain, Body, Chassis, and Diagnostic Circuit Check.

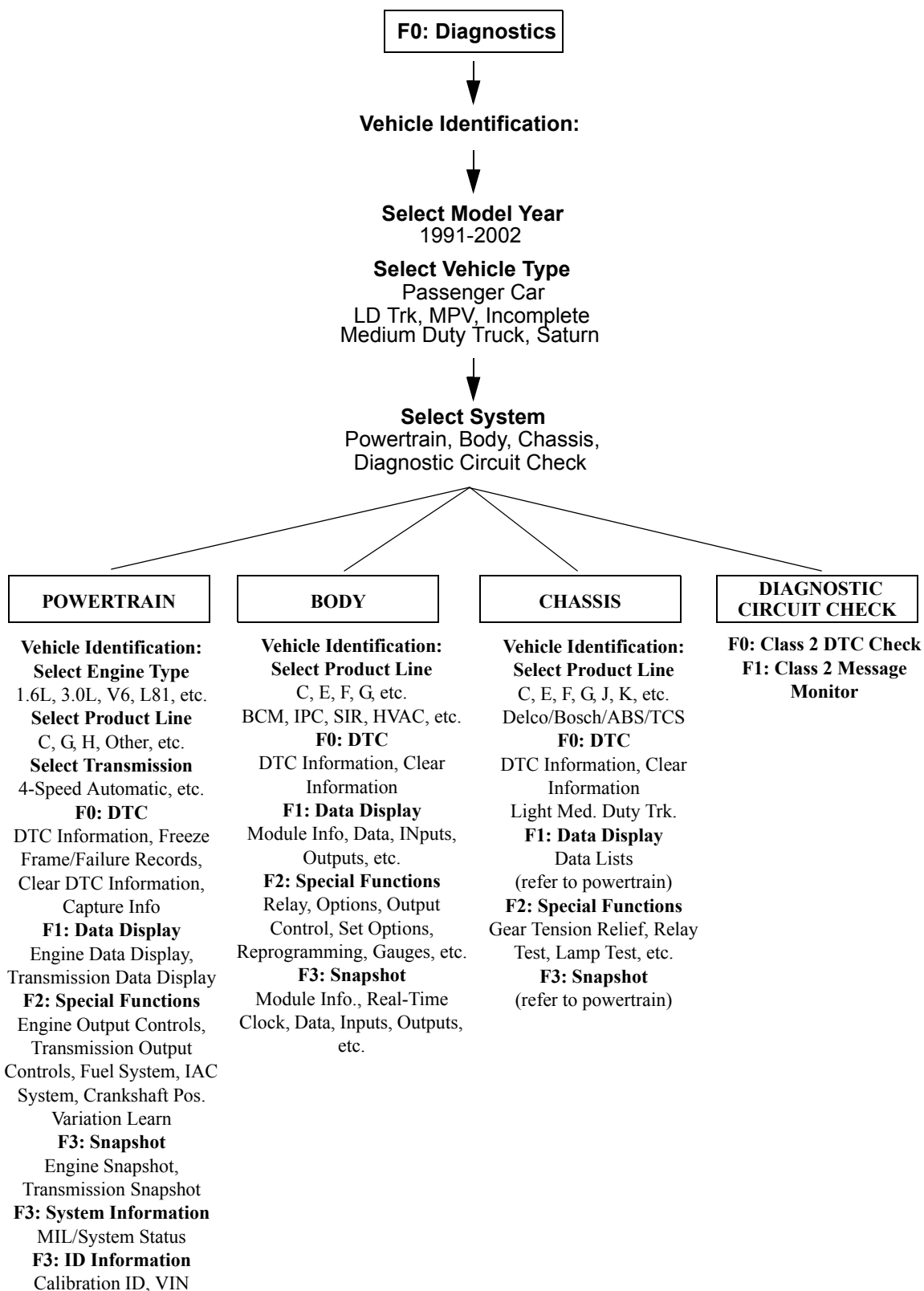

TABLE 8-1. Diagnostics Path

## SERVICE PROGRAMMING AND VIEW CAPTURED DATA

The figures below show the major areas within the Service Programming and View Captured Data categories.

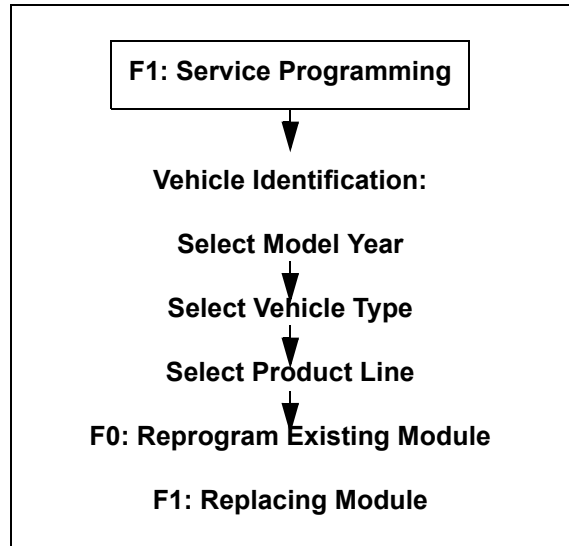

TABLE 8-2. Service Programming Path

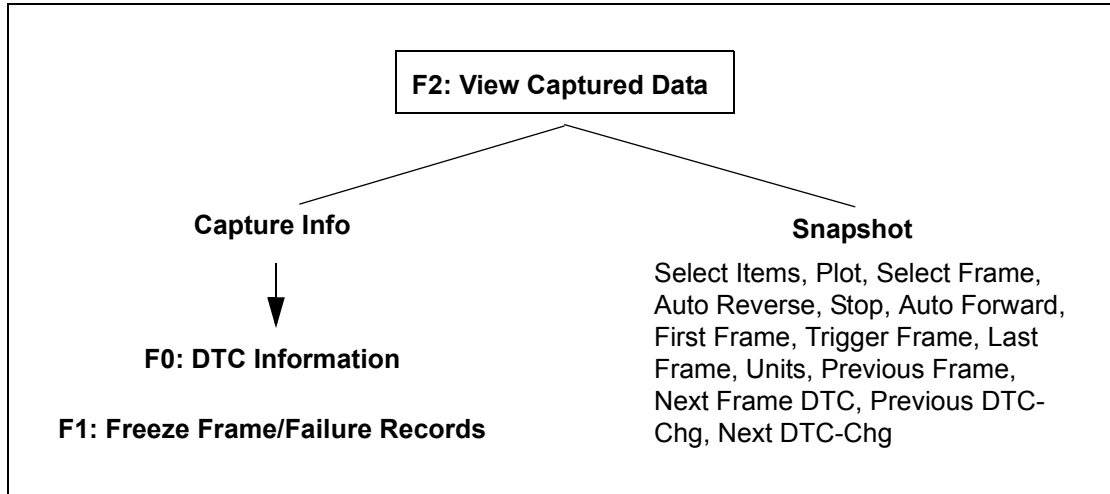

TABLE 8-3. View Captured Data Path

## TOOL OPTIONS AND GETTING STARTED

The figures below show the major areas within the Tool Options and Getting Started categories.

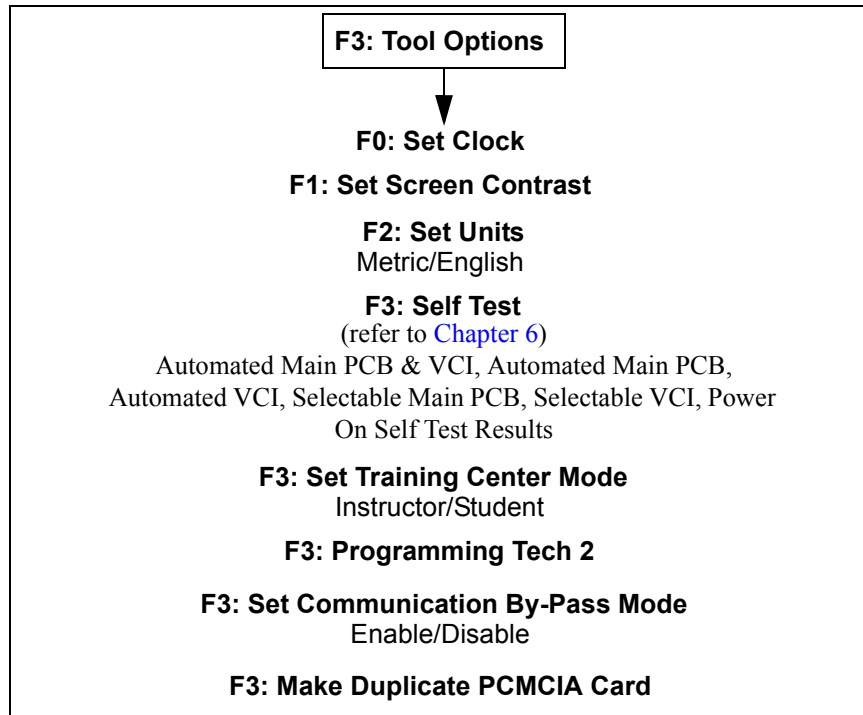

TABLE 8-4. Tool Options Path

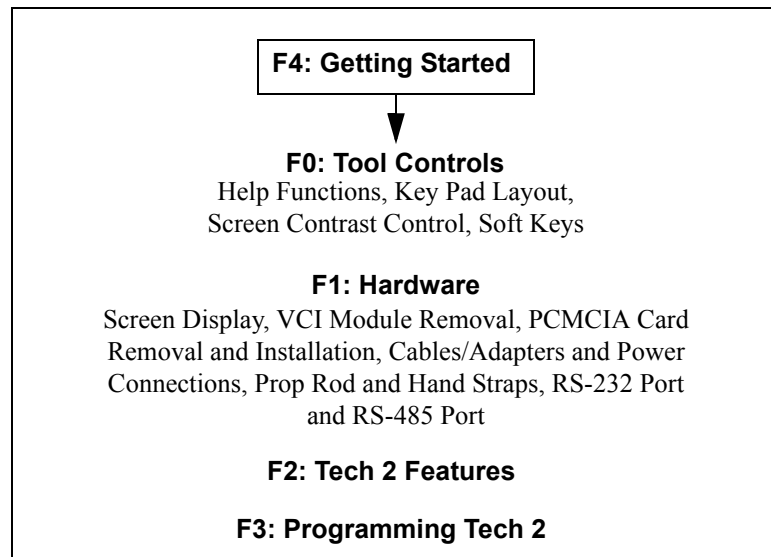

TABLE 8-5. Getting Started Path

## TOOL OPTIONS

Select F3: Tool Options from the Tech 2 Main Menu (Figure 6-2) to obtain the Tool Options menu (Figure 8-2), which provides features you can use to control various Tech 2 settings in addition to the self tests shown in Chapter 6.

### The following functions are available from the Tool Options menu:

- **F0: Set Clock** enables you to set the internal Tech 2 real-time clock.
- **F1: Set Screen Contrast** enables you to adjust screen contrast and save the current setting for various shop lighting conditions.
- **F2: Set Units** enables you to set and save default settings to suit your preference for measurement in English or Metric system units.
- **F3: Self Test** helps you verify that the Tech 2 is functioning normally (Refer to Chapter 6 for complete information).
- **F4: Set Training Center Mode** is for GM Training Centers only.
- **F5: Programming TECH 2** enables you to download software from a PC to the Tech 2 via the RS-232 cable.
- **F6: Set Communication By-Pass Mode** is an engineering function that allows the user to view Data Display without being connected to a vehicle.
- **F7: Make Duplicate PCMCIA Card** enables you to duplicate current PCMCIA card data to a second card.



FIGURE 8-2. Set Clock Selected on Tool Options Menu

## F0: Set Clock

After F0: Set Clock is selected, a Set Real-Time Clock menu appears (Figure 8-3).



FIGURE 8-3. Set Real-Time Menu

### The following methods are available to select areas you need to change:

- Use the up and down arrow keys to move the cursor to desired selection. Press **ENTER** to change the value. Each time **ENTER** is pressed, the value increases by one unit until a preset maximum unit is reached. Once all correct values are entered, press the soft key below Set Clock to save all changes.
- Use the function key of desired selection to change an incorrect value. Each time the function key is pressed the value increased by one unit until a preset maximum is reached. Once all correct values are entered, press the soft key below Set Clock to save all changes.

## F1: Set Screen Contrast

After you select F1: Set Screen Contrast, a Set Contrast Control screen appears (Figure 8-4), providing you with instructions on how to set the screen contrast. After you finish setting the screen contrast, press **EXIT** to save the contrast level for the next Tech 2 power up.

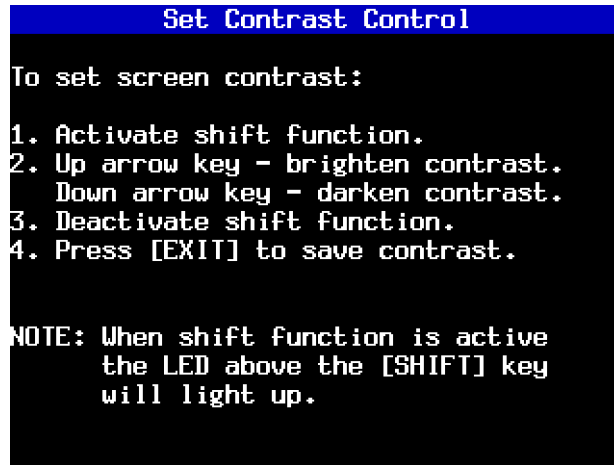

FIGURE 8-4. Set Contrast Control Screen

**Important:** The Screen Contrast Control is designed to adjust the permanent default contrast setting of Tech 2 display.

Because of the nature of the LCD (Liquid Crystal Display), you will experience some contrast variance. When the temperature of the Tech 2 increases the display brightens slightly. As the temperature of the Tech 2 decreases, the display darkens. This variance is a characteristic of an LCD screen and should be considered normal operation.

The screen contrast control setting described above may not account for the entire variance of operating temperatures. Set a default setting which is mid-range between the operating temperatures. Screen contrast may be adjusted during any function by pressing **SHIFT** and using the up and down arrows for adjustment. Periodic adjustments may be necessary, but settings outside of this application are only retained during the current power-up session.



## F2: Set Units

After you select F2: Set Units, a Set Units screen appears (Figure 8-5). The currently displayed unit (either Metric or English) is displayed to the right of Current Units Setting. Use the up and down arrow keys to move the cursor to the desired selection. At the desired selection, press **ENTER** to set or change the Current Units Setting. Once the setting is completed, press **EXIT** to save the current setting for the next Tech 2 power up.

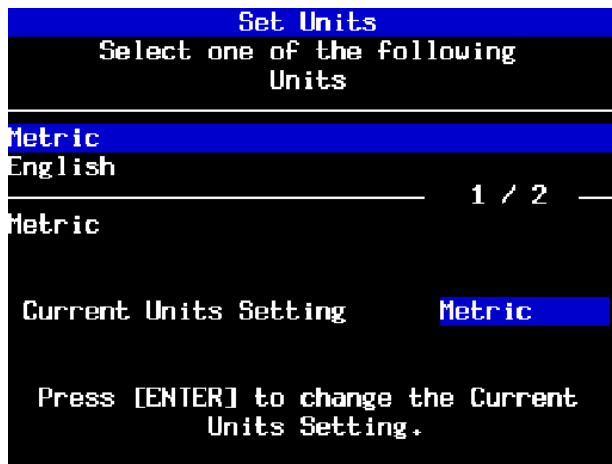

FIGURE 8-5. Set Units Screen

## F3: Self Test

After you select F3: Self Test, a Tech 2 Self Test screen appears (Figure 8-6). Refer to [Chapter 6](#) for complete information.

### Power Down Screen

After completion of any Self Test, return to the Tech 2 Self Test menu screen. After pressing **EXIT**, a screen appears instructing you to turn the Tech 2 power off (Figure 8-7). Turn off the Tech 2 and turn back on to continue.

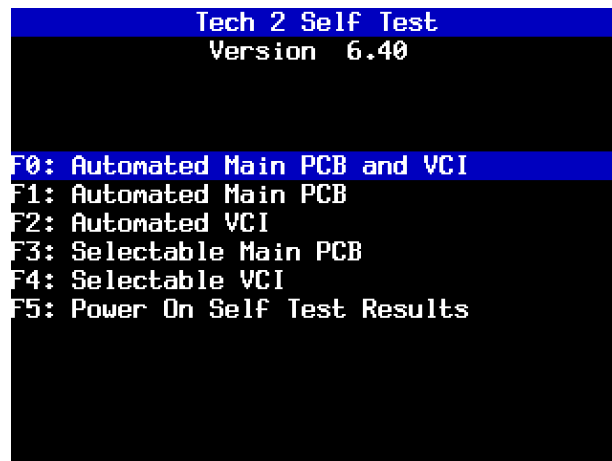

FIGURE 8-6. Tech 2 Self Test Screen

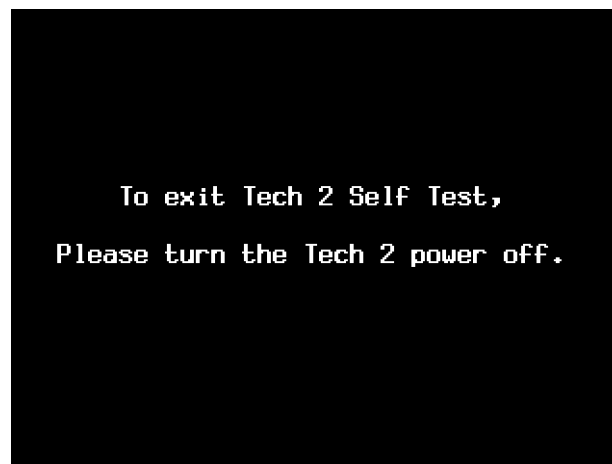

FIGURE 8-7. Tech 2 Power Down Screen

## F4: Set Training Center Mode

After you select F4: Set Training Center Mode, a Set Training Center Mode screen appears (Figure 8-8). This screen gives you the ability to connect multiple Tech 2 scan tools for instructional purposes, which is used at GM Training Centers only.

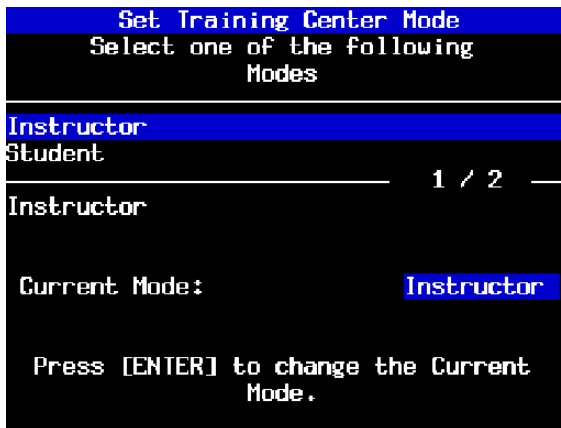

FIGURE 8-8. Set Training Center Mode

## F5: Programming Tech 2

After you select F5: Programming TECH 2, a Programming Tech 2 screen appears (Figure 8-9) with instructions for downloading from a PC to the Tech 2 scan tool.

Follow the on-screen instructions for downloading software. Refer also to [Software Download](#) on page 8-25.

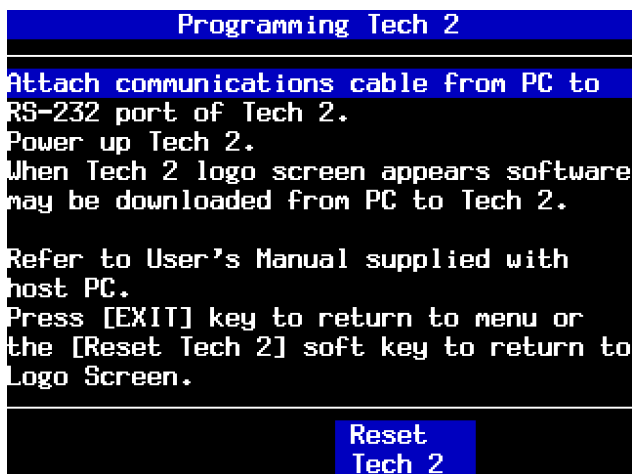

FIGURE 8-9. Programming Tech 2 Screen

## F6: Set Communication By-Pass Mode

After you select F6: Set Communication By-Pass Mode (Figure 8-10), the screen offers Enable and Disable options. By enabling the By-Pass Mode, the Tech 2 bypasses error handling, and allows the user to view data display information without being connected to a vehicle. Highlight the desired setting using the up/down arrow keys, then press **ENTER** to change the current mode. The Tech 2 defaults to the Disable mode once it has been powered off.

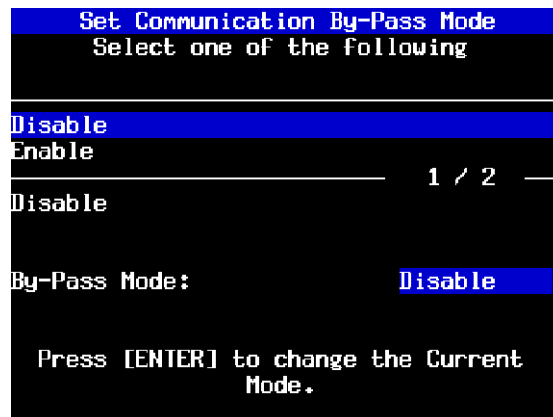

FIGURE 8-10. Set Communication By-Pass Mode Screen

## F7: Make Duplicate PCMCIA Card

This function is used to make an exact duplicate of the current PCMCIA source card. After you select F7: Make Duplicate PCMCIA Card, the display prompts you to insert the destination card (the PCMCIA card that you want to update) into the open PCMCIA card slot, then press **ENTER** to continue. The PCMCIA Card Duplicator screen (Figure 8-11) appears, showing the current version of both cards. The highlighted areas on the screen represent the locations of the source and destination PCMCIA cards. Slot 1 is defined as the slot closest to the Tech 2 display. Use the Copy soft key to initiate the duplication process.



FIGURE 8-11. PCMCIA Card Duplicator Screen

## GETTING STARTED

Select F4: Getting Started from the Tech 2 Main Menu (Figure 8-12) to obtain the Getting Started Menu (Figure 8-13). The Getting Started Menu provides an on-line overview of the Tech 2 and useful operation information.

### The following options are available from the Getting Started Menu:

- **F0: Tool Controls**-The Tool Controls Menu (Figure 8-14) provides information on Tech 2 help functions, keypad layout, screen contrast control, and soft keys.
- **F1: Hardware**-The Hardware Menu (Figure 8-15) provides information on screen display, VCI module removal, PCMCIA card removal and installation, cables/adapters and power connections, prop rod and hand straps, and RS-232 and RS-485 ports.
- **F2: Tech 2 Features** displays a vehicle information entry sequence for a fictitious vehicle (Figure 8-16).
- **F3: Programming Tech 2** provides instructions for downloading from a PC to the Tech 2 scan tool. This option duplicates Tool Options Menu function F5: Programming TECH 2 (see Figure 8-2 and Figure 8-9).



FIGURE 8-12. Getting Started Selected on Tech 2 Main Menu



FIGURE 8-13. Getting Started Menu



FIGURE 8-14. Tool Controls Menu

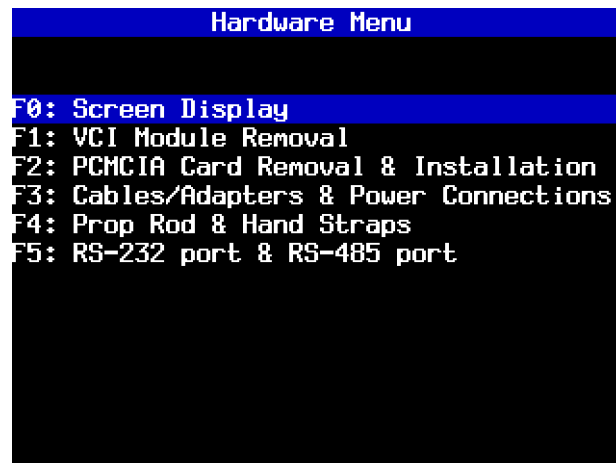

FIGURE 8-15. Hardware Menu

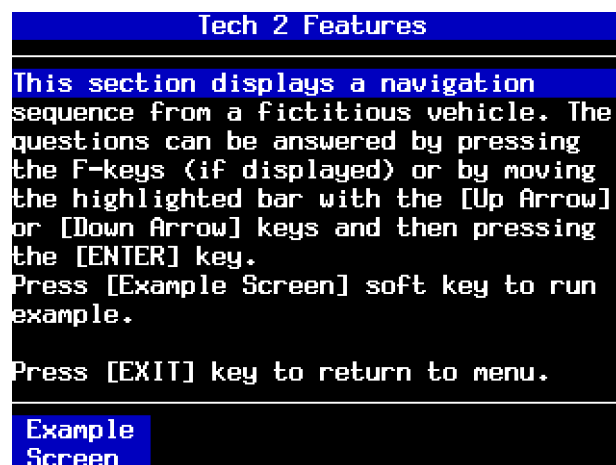

FIGURE 8-16. Tech 2 Features Screen

## TECHLINE INFORMATION SYSTEM 2000 (TIS 2000)

Techline Information System 2000 (TIS 2000)\* is a component-oriented service information delivery system that allows technicians to perform SPS, update the Tech 2, and view Tech 2 snapshot data in a Windows 95 environment.

To start TIS 2000, double click its icon in the Techline Information System group on the desktop screen of your Techline terminal. TIS 2000 supports service programming with the Tech 2 scan tool only.

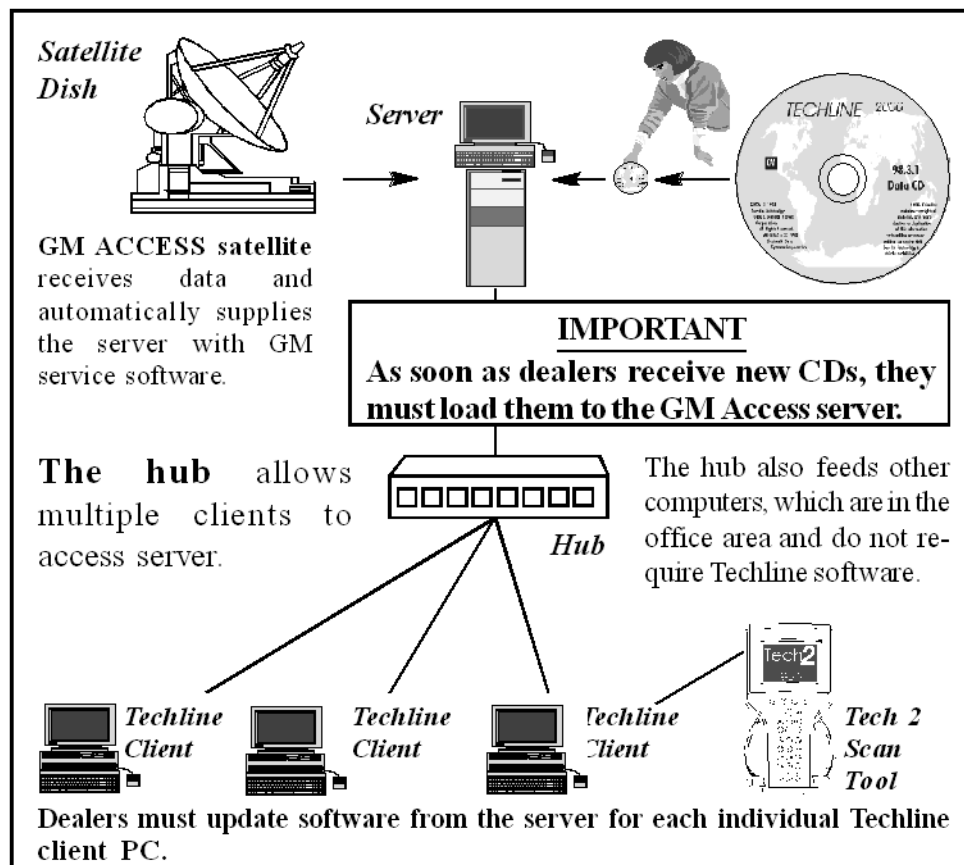

FIGURE 8-17. Techline System Overview

\*. At the time of publication, TIS 2000 software available in English only.

---

## GLOSSARY

Client	The Techline client PC is the service area PC that is connected to the GM Access server (most are IBM PCs).
Hub	A hub is a device used to connect several clients to the GM Access server (most are eight-station hubs).
Icon	A graphic symbol on the computer screen (often with text) that represents a file folder or a specific software application.
LAN	Local Area Network. A communications system within a dealership that allows employees using several Techline client PCs to obtain data from the GM Access server.
Loading Procedure	Installation of software on a computer.
Login/Logon	To start a session within a system, usually by giving a user name and password as user authentication.
Logoff	To return to the logon screen by properly exiting the software program.
Password	A security feature allowing only you authorization on the Techline client PC applications.
Server	The GM Access computer from which the Techline PC clients can download applications (most are Compaq PCs).
User Name	The name that identifies a Techline client PC user to software on the GM Access server (techuser01).



## SERVICE PROGRAMMING SYSTEM (SPS)

The Service Programming System (SPS) updates the calibration files that are stored in a vehicle on-board controller (e.g., ECM, PCM, VCM). The calibration file custom-tailors a module to a certain vehicle. The calibration file contains data for things such as spark curves and fuel control. When troubleshooting a driveability problem, diagnosis may call for reprogramming the controller with newer calibration information to correct a customer concern.

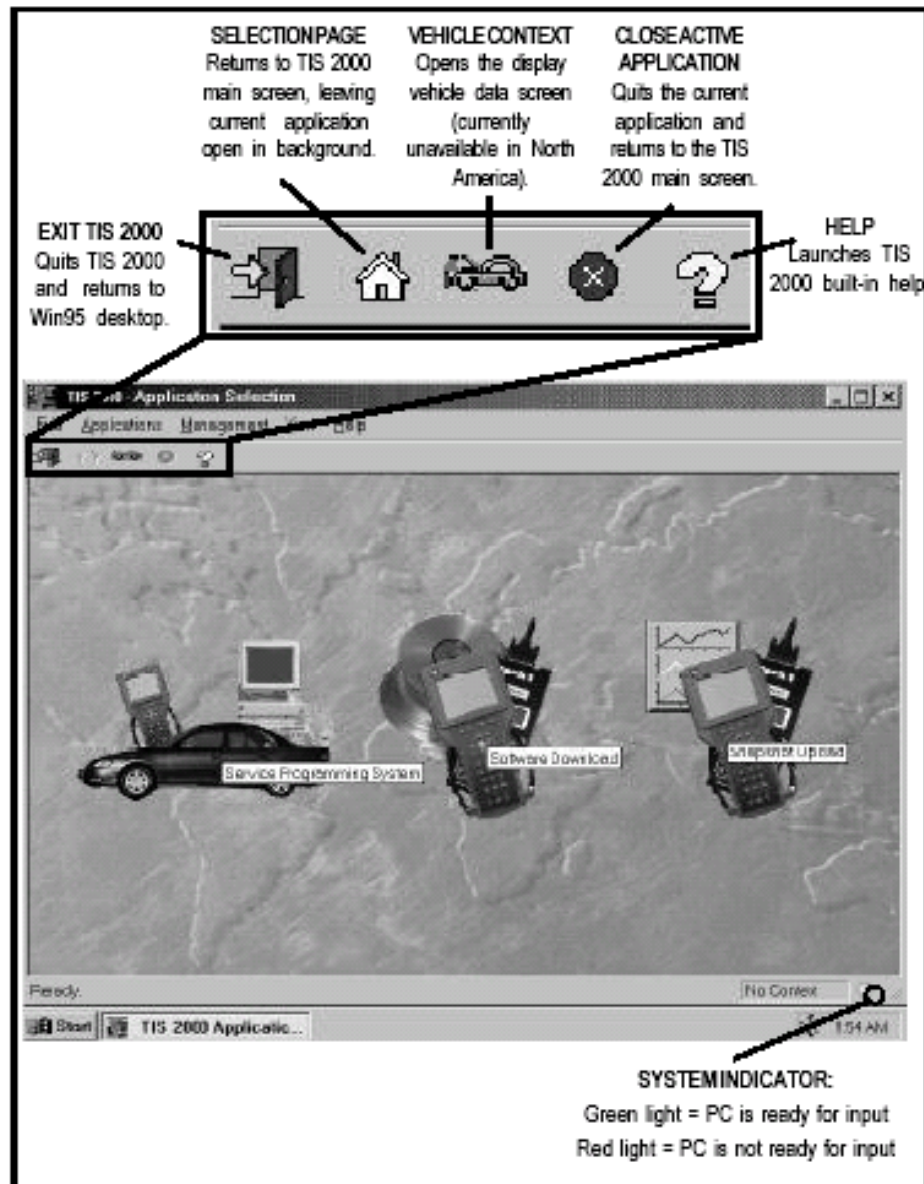

FIGURE 8-18. TIS 2000 Main Screen (Application Selection)

**NOTE**

Battery voltage should be checked. A fully charged battery is necessary before reprogramming takes place. The vehicle battery should not be connected to a battery charger during a programming event. Incorrect voltage could cause programming and/or control module failure. During programming, the control module depends on the battery as its sole source of power. Also during programming, the vehicle's components (i.e. blower motor) are set to a default mode which may be turned on, placing additional draw on the vehicle's battery. If the voltage goes outside the specified range (11 to 14 volts) the controllers and the Techline equipment stops communicating. If this happens, it could cause the control module to become inoperable and require replacement.

Check the integrity of the Tech 2 cables, make sure they are not frayed, broken, or twisted. Loss of communication for any reason requires additional time in completing the reprogramming event.

Do not discontinue or interrupt the program loading process to the vehicle. This may result in a programming error and could prevent the vehicle on-board controller from functioning properly.

## REMOTE SPS PROGRAMMING

**The Remote SPS method is a three-step process that involves:**

1. Connecting the scan tool to the vehicle and obtaining information from the controller.
2. Connecting the scan tool to the PC and downloading a new calibration file from the PC to the scan tool's memory.
3. Reconnecting the scan tool to the vehicle and uploading the new calibration file to the controller.

## PERFORMING REMOTE SPS

**Important! Prior to performing SPS:**

- Ensure that the Tech 2 and the terminal are both equipped with the latest software.
- Ensure that the vehicle battery is fully charged. Battery voltage for SPS should be between 12.5 and 14 volts. However, make sure a battery charger IS NOT connected to the vehicle.
- Ensure that cable connections are secure. A disconnected cable could cause controller failure.

**Perform remote SPS using TIS 2000 as follows:**

1. Obtain Vehicle Information:
  - a. With the Tech 2 and vehicle both off, connect the Tech 2 to the vehicle DLC ([Figure 3-23](#)).
  - b. Start the Tech 2. At the Tech 2 title screen, press **ENTER**.
  - c. Turn the vehicle ignition to on (engine not running).

- d. At the Tech 2 Main Menu, select F1: Service Programming and enter/identify vehicle information as requested by the Tech 2. As needed, identify the type of module being programmed.
- e. Press the Request Info soft key on the Tech 2.
- f. At the next screen ([Figure 8-19](#)), identify whether an existing module or a new module is being programmed.

For an existing module, the Tech 2 obtains calibration information from the controller.

For a new module, the Tech 2 instructs you to remove the old module and install the new module in the vehicle. When you complete this step, press the Done soft key on the Tech 2. The Tech 2 then communicates with the new controller, receiving an access code that enables you to program the Tech 2.



FIGURE 8-19. Service Programming Menu

- g. Verify that the displayed VIN matches the vehicle VIN, then press **Yes** to continue.
    - If the displayed VIN does not match the actual vehicle VIN, write down the actual VIN. You will have a chance to input the correct VIN at the terminal.
  - h. When complete, press **EXIT**, power down, and disconnect the Tech 2 from the vehicle. Turn the vehicle ignition off.
2. Transfer Data from the PC to the Tech 2
    - a. Connect the Tech 2 to the terminal, as shown in [Figure 8-20](#).

**NOTE**



Connection location varies depending on terminal configuration.

- b. At the terminal, start TIS 2000.
- c. From the TIS 2000 main screen (refer to [Figure 8-18](#)), select **Service Programming System**.

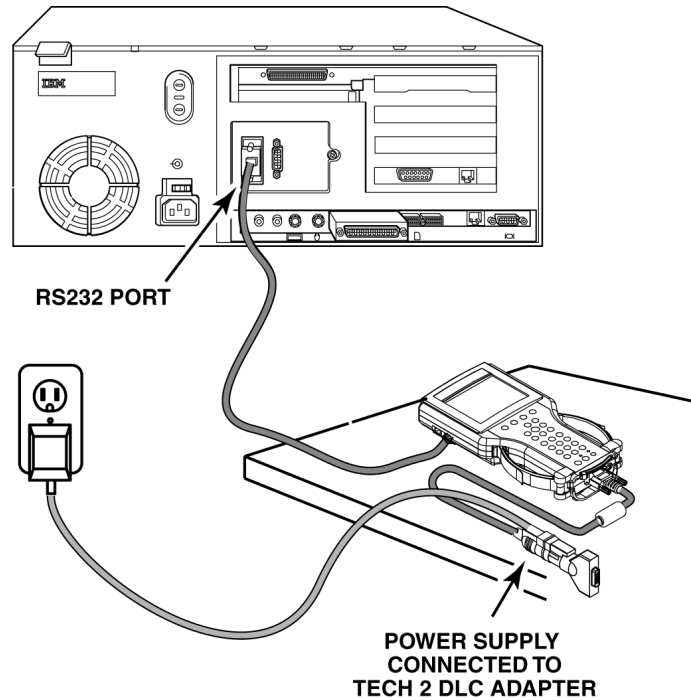

FIGURE 8-20. Tech 2 to PC Terminal Connection

- d. At the Select Diagnostic Tool and Programming Process screen (Figure 8-21) make the appropriate selection for your procedure:
  - Under Select Diagnostic Tool, select **Tech 2**.
  - Under Select Programming Process, identify whether an existing module is being reprogrammed or a module is being replaced with a new one.
  - Under Select ECU Location, identify whether on-vehicle or off-board programming is being performed.
- e. After making selections, select **Next**.
- f. A reminder screen appears for making the appropriate connections (Figure 8-22). Select **Next** after confirming connections.
- g. A screen appears, asking to confirm the VIN (Figure 8-23). After confirming/entering the correct VIN, select **Next**.

A Supported Controllers screen (Figure 8-24) appears asking to identify the type of controller being programmed. Some vehicles may have more than one programmable controller-examples include PCM, BCM, VDT, IPC.

- h. Select the appropriate controller for the vehicle being serviced.
- i. Identify the type of programming to be performed.

Normal is used for updating an existing calibration or programming a new controller.

VCI (Vehicle Configuration Index) is also used for updating an existing controller or programming a new controller, but is used for newer vehicles whose VINs aren't yet in the database. For these vehicles, contact Techline Customer Support, at 1-888-337-1010 for assistance.

Reconfigure is used to reconfigure a vehicle, such as a truck, for changes in tire size and axle ratios.

j. After making selections, select **Next**.

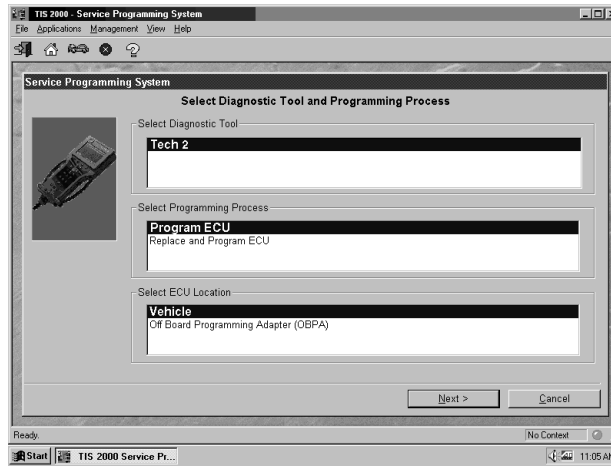

FIGURE 8-21. Select Diagnostic Tool and Programming Process Screen



FIGURE 8-22. Connect Diagnostic Tool Screen

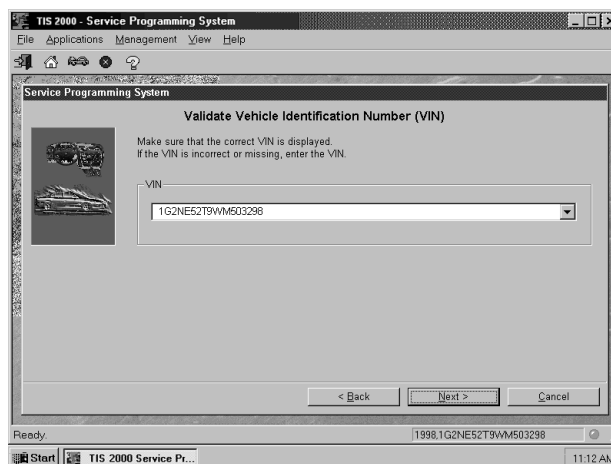

FIGURE 8-23. Validate Vehicle Identification Number (VIN) Screen

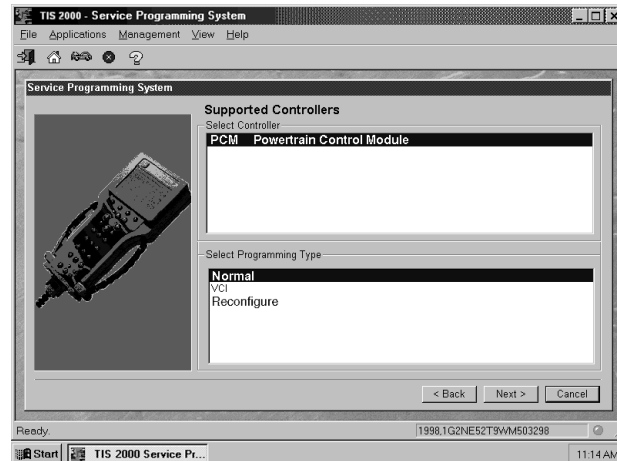

FIGURE 8-24. Supported Controllers Screen

k. A Calibration Selection screen appears showing the calibration file history for the vehicle/controller being serviced. There are explanations of each calibration file. Based on the descriptions, select the appropriate file.

- Vehicles with PCMs display a screen similar to the one shown in [Figure 8-25](#).
- Vehicles with VCMs display a screen similar to the one shown in [Figure 8-26](#). It contains multiple “tabs”—one for each distinct calibration file contained in the VCM. With these vehicles, it is necessary to make a selection within each tab, otherwise the system displays the message shown in [Figure 8-27](#), indicating that not all selections have been made (notice the unchecked box in the system tab).

The following icons appear on the calibration selection screen(s):

- A circle with a slash indicates a file that is not selectable.
- An open box indicates a file that is selectable.
- A box with a check mark indicates a valid file/option that has been selected.
- If service bulletins are listed along with the calibration files, the bulletins should be referred to before service programming is performed, then select Next.

l. After making the necessary selections, a Summary screen appears ([Figure 8-28](#)) allowing you to confirm your selection. Select **Next** to continue.

m. A Transfer Data screen appears ([Figure 8-29](#)). Select **Reprog** to initiate the download of the new calibration file to the Tech 2.

The screen tracks the progress of the download.

After the download is complete, a screen appears with instructions for connecting the Tech 2 to the vehicle to complete the programming process ([Figure 8-30](#)).

n. Close the application to return to TIS 2000, then power down and disconnect the Tech 2 from the PC.

### 3. Transfer Data From the Tech 2 to the Control Module

- a. With the Tech 2 and vehicle both off, connect the Tech 2 to the vehicle DLC (refer to [Figure 3-23](#)).
- b. Start the Tech 2. At the Tech 2 title screen, press **ENTER**.
- c. Turn the ignition ON (engine not running).

- d. At the Main Screen, select **F1: Service Programming** and enter vehicle information as requested by the Tech 2.
- e. Select the **Program** soft key on the Tech 2.
 

The Tech 2 displays the message Downloading Calibration File while data is transferred.

When the transfer is complete, the Tech 2 displays the message Reprogramming Successful.
- f. Press **EXIT** to exit the program. Turn the vehicle ignition off first, then turn the Tech 2 off and disconnect it from the vehicle.

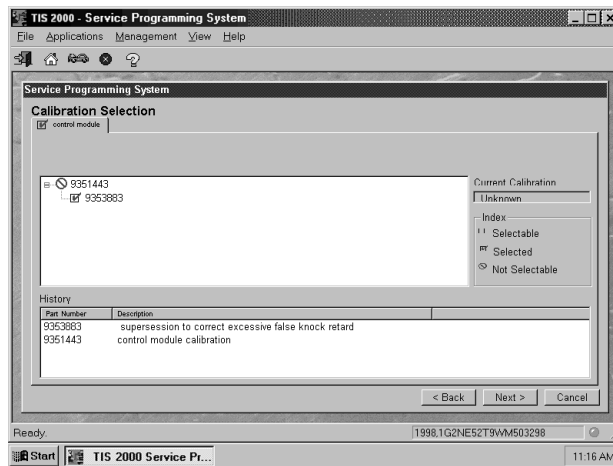

FIGURE 8-25. Control Module Folder on Calibration Selection Screen

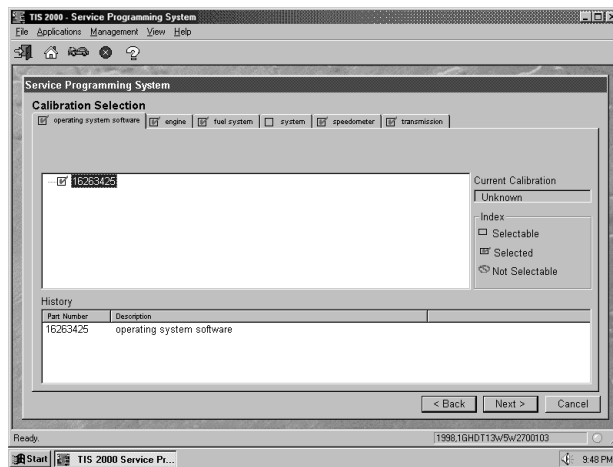

FIGURE 8-26. Operating System Software Folder on Calibration Selection Screen

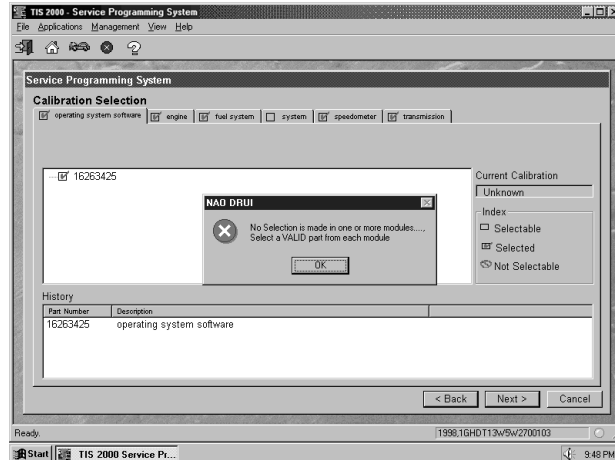

FIGURE 8-27. Incomplete Module Selection Message on Calibration Selection Screen

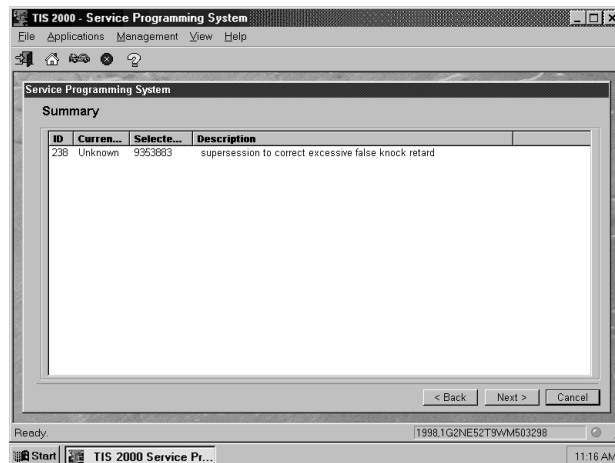

FIGURE 8-28. Summary Screen

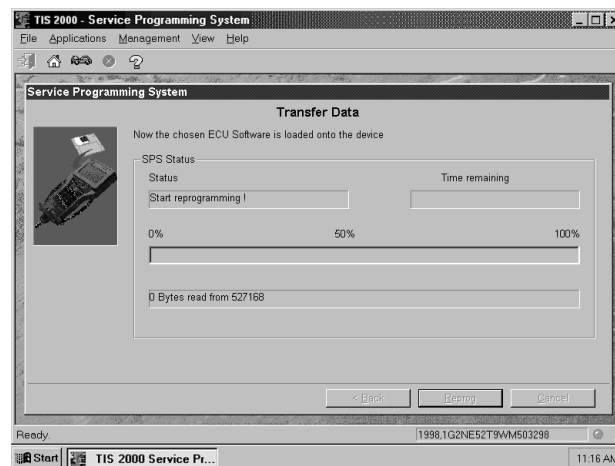

FIGURE 8-29. Transfer Data Screen



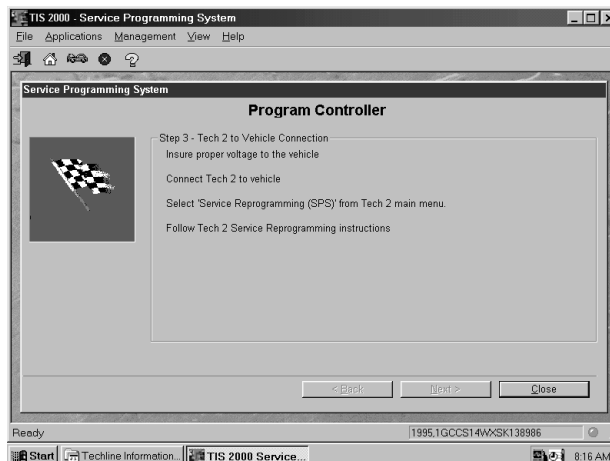

FIGURE 8-30. Program Controller Screen

## VERIFYING REPROGRAMMING

After any kind of control module programming, verify that programming was successful. Turn the ignition off, wait at least 30 seconds, then start the vehicle to confirm that reprogramming was successful. If the vehicle does not start or starts but runs rough, repeat the SPS procedure.

### NOTE



Some vehicles require that Idle Learn, TP Learn, Theft Deterrent Relearn, or Crankshaft Variation Learn procedures be performed after programming. Consult the appropriate service information for these procedures.

Former versions of this manual included [Figure 8-31](#) and [Figure 8-32](#). These features are no longer relevant.

## SOFTWARE DOWNLOAD

The software download function of TIS 2000 is used to update Tech 2 Scan Tool software to the latest version. Like all computers, the Tech 2 scan tools each store software that determine how they run and what they can do. This software allows the scan tools to perform diagnostic routines on/for the following vehicle applications: Powertrain; Body; Chassis; and Service Programming.

**Scan tool software is regularly updated to reflect changes in vehicle engineering or diagnostics. Updates can include:**

- New vehicle system coverage.
- Improvements to diagnostic procedures.
- Updates to original application releases.
- The addition of new diagnostic procedures.

## PCMCIA Card

Tech 2 software is stored on a Personal Computer Memory Card Industry Association (PCMCIA) card (Figure 3-8 and Figure 3-9). The contents of the card are not distinct applications as is the case with certain Tech 1 cartridges.

All of the applications share a single database of information on the Tech 2's PCMCIA card.

The PCMCIA card is accessed through a door on top of the unit, and should only be removed if instructed by the Techline Customer Support Center. The card is ejected by pushing the arrow button pointing to card to be removed. Cards are notched to allow insertion only one way. When reinserting the card make sure that it fully seats into the Tech 2. The PCMCIA card fits into slot "zero" which is closest to the screen.

A second slot exists for non North American Operations (NAO) vehicle software. The second slot is identified as slot "one."

### NOTE



The PCMCIA card is sensitive to magnetism and static electricity. Use care when handling.

A write-protected slide mechanism is on the top edge of the card under a white plastic CPA-type device. The correct position is to the middle of the card (unlocked). If the write protect is in the locked position, snapshots and Capture Info. cannot be stored, and Service Programming does not work.

## TECH 2 UPDATE PROCEDURES

The Software Download function of TIS 2000 allows updating of the Tech 2 with the latest service information. The Software Download function transfer (downloads) updated scan tool software from the terminal to the scan tool. There are two download modes: Standard and Custom.

### Standard Update

#### To perform a Standard Tech 2 update:

1. Connect the scan tool to the terminal using the RS-232 cable (Figure 8-20).
2. Power up the scan tool using the AC power supply that came with the tool (refer to Figure 8-20).
3. At the terminal, start TIS 2000.
4. From the TIS 2000 main screen, select the Software Download icon (refer to Figure 8-18).
5. At the Select Diagnostic Tool for Download screen, highlight and verify your selection (Figure 8-33).
  - Standard installs the newest software onto the scan tool.
  - Custom allows backdating or installing of non-NAO software onto the scan tool.

6. After confirming the selection, select Next.

A message appears indicating the terminal is reading the contents of the diagnostic tool.

7. The terminal displays a Confirm Software Change screen (Figure 8-34) showing what the Tech 2 currently contains and what it will contain after the download. Select Next to continue.

A Performing the Software Download screen appears (Figure 8-35). It tracks the status of the download.

When the download is complete, a Download Finished screen appears (Figure 8-36).

8. Select Close to close the application. The scan tool now contains the latest software.

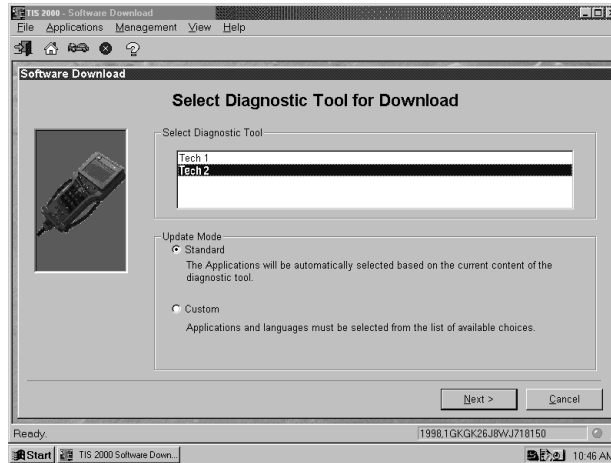

FIGURE 8-31. Select Diagnostic Tool for Download Screen



FIGURE 8-32. Confirm Software Change Screen

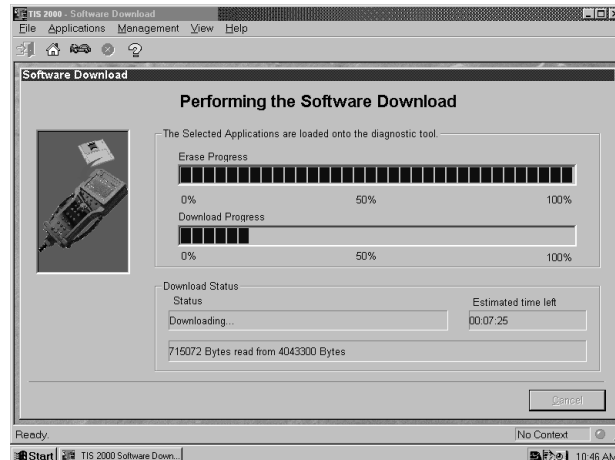

FIGURE 8-33. Performing the Software Download Screen

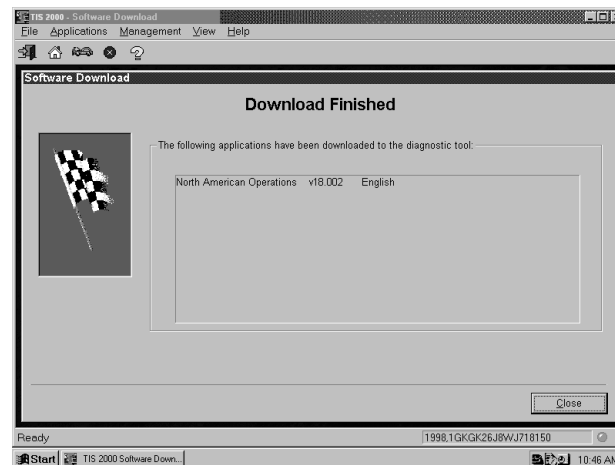

FIGURE 8-34. Download Finished Screen

## Custom Update

A Custom update is used to backdate the scan tool or install different language software.

### To perform a Custom Tech 2 update:

1. Connect the scan tool to the terminal using the RS-232 cable (Figure 8-20).
2. Power up the scan tool using the AC power supply that came with the tool.
3. At the terminal, start TIS 2000.
4. From the TIS 2000 main screen, select the Software Download icon (refer to Figure 8-18).
5. At the Select Diagnostic Tool for Download screen (Figure 8-33), highlight and verify your selection.

Custom allows backdating or installing of non-NAO software onto the scan tool.

6. After confirming the selection, select Next.

A message appears, indicating the terminal is reading the contents of the diagnostic tool.

A Select the Applications screen (Figure 8-37) appears. The left side of the screen lists software release numbers.

7. Select the “+” sign to see a list of different languages for each release (Figure 8-38).
8. Select the desired software version and language by either double-clicking or highlighting the desired language file, then choose Select.

The selected software appears in the right side of the screen (Figure 8-38).

9. To compare the current and selected scan tool software, click on the tabs on the right side of the screen (Figure 8-39).

A Performing the Software Download screen appears (refer to Figure 8-35). It tracks the status of the download.

When the download is completed, a Download Finished screen appears.

10. Select Close to close the application.

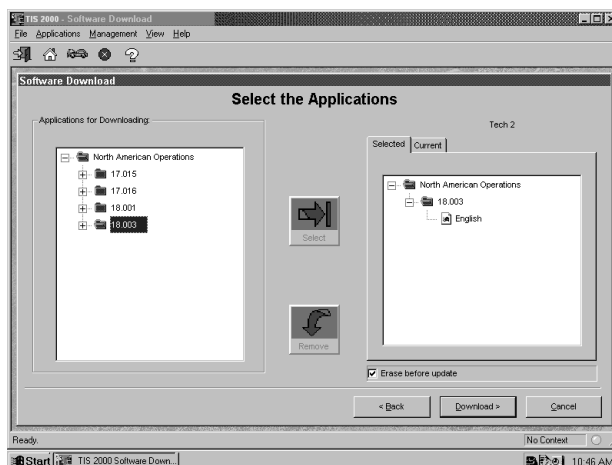

FIGURE 8-35. Select the Applications Screen

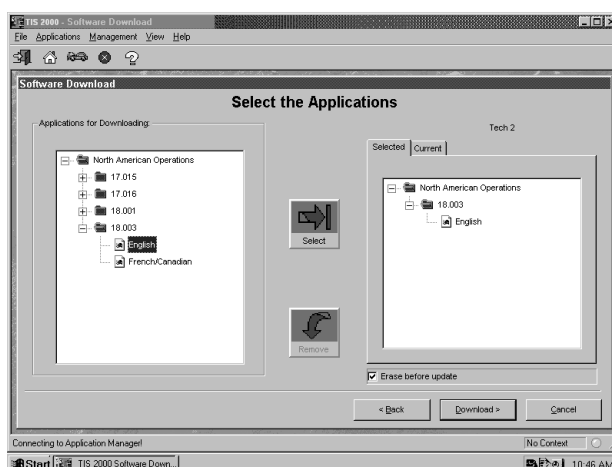

FIGURE 8-36. Select the Applications Screen, Showing Languages Available for Release

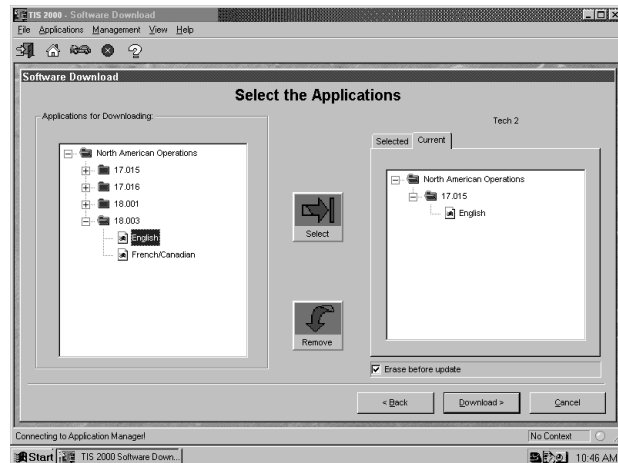

FIGURE 8-37. "Current" Folder Selected on Select the Applications Screen

## SNAPSHOT UPLOAD

The Snapshot Upload function of TIS 2000 provides a means for viewing scan tool snapshot data, as well as freeze frame and capture data info on the terminal. This data can be analyzed in a variety of ways to determine when and where a fault may have occurred.

### Using the Snapshot display feature involves three steps:

1. Capture snapshot(s) with the scan tool.
2. Upload the snapshot(s) to the terminal.
3. View the snapshot(s) using the TIS 2000 Snapshot Upload function.

### To Capture a Snapshot of the Vehicle Data Stream:

1. Connect the Tech 2 to the vehicle Data Link Connector (DLC). (Refer to [Tech 2 Connection to PC](#) on page 3-17.)
2. Power up the Tech 2 and enter vehicle information as requested on the scan tool's display.
3. From the Application Menu, select F3: Snapshot.
4. At the next screen, select the desired system to snapshot (e.g., engine, transmission).
5. At the next screen, select the desired data list (e.g., engine 1, engine 2).
6. At the next screen, select the trigger type and trigger point.

Trigger Type (F0-F3 function keys) determines how the snapshot is triggered:

- **F0: Manual Trigger** triggers a snapshot when you press the Trigger soft key.
- **F1: Any Code** triggers a snapshot whenever any current trouble code is stored. This event occurs when the first code is stored in the vehicle controller memory.
- **F2: Single Code** triggers a snapshot when a user specified trouble code is stored.

- **F3: Automatic Trigger** (chassis applications only) automatically triggers a snapshot.

**Trigger Point** (F4-F6 function keys) is the exact point at which the trouble code (fault) or manual trigger occurs within the snapshot period. It helps to know the trigger point when you are looking for changes in data parameters. Trigger point may be set for:

- **F4: Beginning** causes the Tech 2 to start recording information from the trigger point until snapshot storage is full. This choice is useful if the fault is predictable in nature.
  - **F5: Center** is the most commonly used trigger point because it stores information leading up to and following the trigger point. This function allows comparison of events before, during, and after a fault.
  - **F6: End** sets the trigger point at the end of the snapshot recording and therefore shows only information leading up to and including the fault.
7. Press the Record Snapshot soft key. The Tech 2 screen displays a flashing “standby” message.
    - When the fault occurs, press the Trigger soft key.
    - The Tech 2 displays the “triggered” message.
    - Allow the scan tool to record a sufficient amount of data, then press **EXIT** to store the snapshot data.
    - Press the Continue soft key when the snapshot trigger type screen is displayed.
  8. Exit to the Main Menu, then power down and disconnect the Tech 2 from the vehicle.

## UPLOADING THE SNAPSHOT TO THE PC

**After a snapshot has been successfully captured, perform the following steps to upload it from the scan tool to the computer:**

1. Start TIS 2000.
2. Select Snapshot Upload from the TIS 2000 main screen (refer to [Figure 8-18](#)).
3. Select the Snapshot Upload icon from the Tool Bar (the first icon in the toolbar).

### **OR**

Select the Upload from Handheld box in the center of the screen ([Figure 8-40](#)).

4. Select the appropriate scan tool and verify the Tech 2 connection to the terminal, then select OK ([Figure 8-41](#)).
5. Select the snapshot to be uploaded, then select OK.

After the snapshot uploads, a list of data parameters displays on the monitor (see [Figure 8-42](#)).



FIGURE 8-38. Snapshot Upload Screen Showing Two Choices

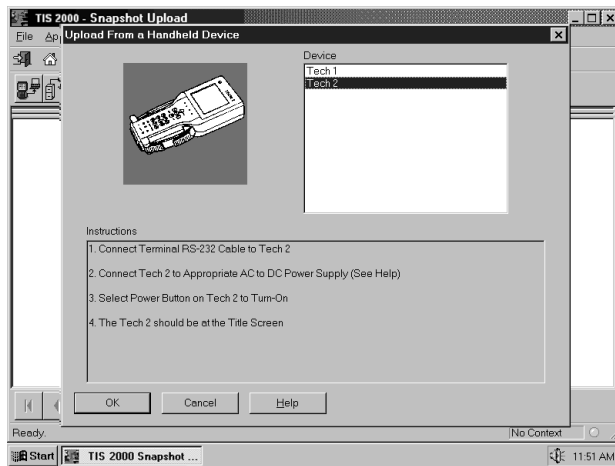
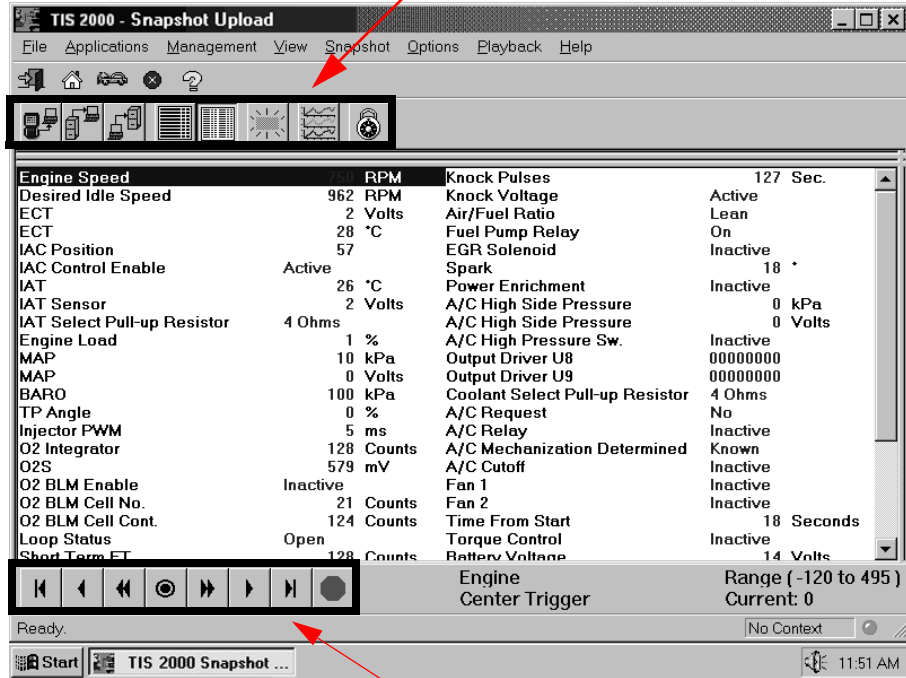
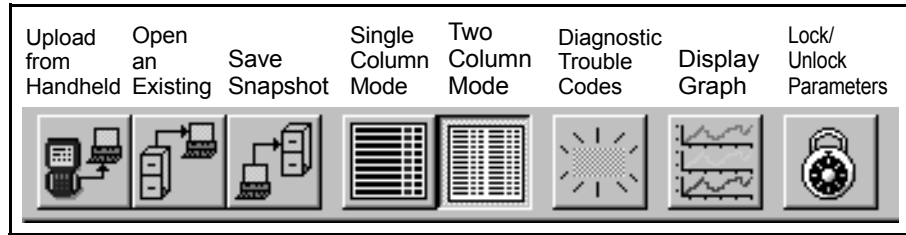

FIGURE 8-39. Upload from a Handheld Device Screen





REPLAY SELECTIONS

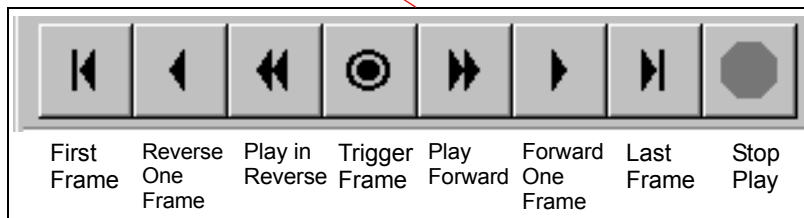

FIGURE 8-40. Snapshot Display Showing Two-Column Mode

## VIEWING THE SNAPSHOT

After a snapshot has been uploaded (either from disk or the scan tool), it can be viewed and analyzed in a variety of ways. [Figure 8-42](#) identifies the different display icons and replay selections.

## REPLAYING THE SNAPSHOT

To replay a snapshot, use the icons displayed as a row of selections in the lower left-hand portion of the screen.

**The selections and their functions are as follows (refer to [Figure 8-42](#)):**

- First Frame displays the first frame of the snapshot, regardless of which frame was displayed prior to selection.
- Reverse One Frame moves the display to the frame immediately preceding the one currently displayed.
- Play in Reverse causes the snapshot to continuously play in reverse, until the first frame is displayed.
- Trigger Frame causes the display to move to the exact frame when the snapshot was triggered, regardless of which frame was displayed before the button was selected.
- Play Forward causes the snapshot to continuously play forward until the last frame is reached.
- Forward One Frame moves the snapshot forward to the next frame.
- Last Frame takes the snapshot to the very last frame.
- Stop Play causes a continuous play snapshot to stop at the frame when the button was selected.

## SINGLE-COLUMN VERSUS TWO-COLUMN DISPLAY

**The Two-Column and Single-Column icons in the toolbar change the appearance of data parameters.**

- Two-Column (see [Figure 8-42](#)) displays a double-list. When using two-column mode, the maximum number of characters of any one line is 80.
- Single-Column (see [Figure 8-43](#)) lists data parameters in a single column that uses larger type, which makes the data easier to read at a distance.

A default (Single or Two-Column mode) can be set by accessing Options from the menu bar.

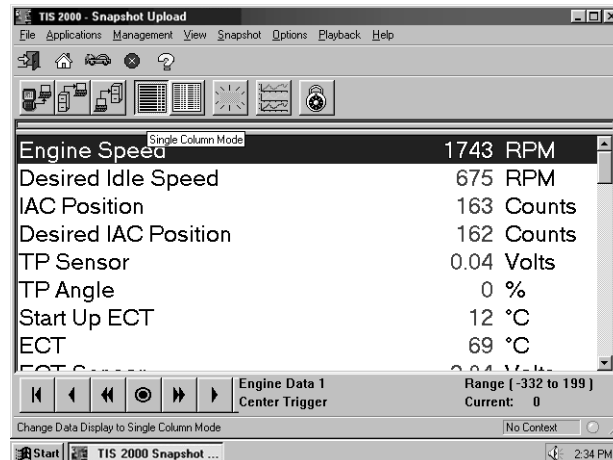

FIGURE 8-41. Single Column Mode on Snapshot Upload Screen

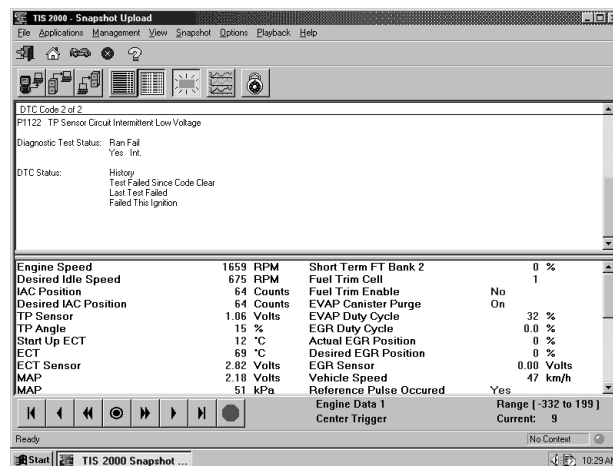

FIGURE 8-42. DTC Information on Snapshot Upload Screen

## DISPLAYING DIAGNOSTIC TROUBLE CODES

The Diagnostic Trouble Code icon displays all relevant trouble code information for each individual frame of a snapshot. It is important to note that when replaying a snapshot, every frame of the snapshot may not have a stored DTC.

### To use the DTC display feature:

1. Click on the DTC icon in the toolbar.

A box appears near the top of the screen listing DTC information (Figure 8-44). The following information is provided:

- The first line indicates how many codes are in the frame—for example, “1 of 2,” “2 of 2,” etc. This is not the total number of DTCs stored in the entire snapshot, just in the individual frame being displayed.

- The number and name of the DTC.
  - “Diagnostic Test Status” states whether the test ran and whether it passed or failed.
  - “DTC Status” lists the DTC information. This is the status of the tests that were run and the related DTC messages that can be viewed by the technician. This information is based only on the DTC information listed, since some DTC information is not be available on all applications.
2. If more than one DTC is set for a frame, scroll bars appear at the right side of the DTC window. To view other DTCs (Figure 8-45), click-and-drag the scroll box or use the scroll arrows.
  3. To determine exactly when a DTC set during a snapshot, use the Play Forward and Play in Reverse buttons to play the snapshot with the DTC window still in view. DTC information continues to display for all the frames during which the DTC was set. This information can be useful for diagnosing DTCs by displaying related data parameters at the point in time when the code was set.

**TIP!**

A quick way to see if a code was set during a snapshot is to go to the last frame of the snapshot, then select the DTC icon. This shows any and all DTCs set during the snapshot, since DTCs are stored for the duration of the snapshot.

4. When a frame is reached for which there is no DTC, the message “No Diagnostic Troubles for this data frame” displays in the DTC window (Figure 8-46).

**TIP!**

In most snapshots, DTCs are set near the trigger frame. To quickly locate the frame where a DTC occurred, click on the “Trigger Frame” button. Then use the “Forward 1 Frame” or “Reverse 1 Frame” buttons to view the frames just before and after the trigger frame. Chances are, the DTC appears within these frames. If not, continue viewing the snapshot using the “Play Forward” or “Play in Reverse” button.

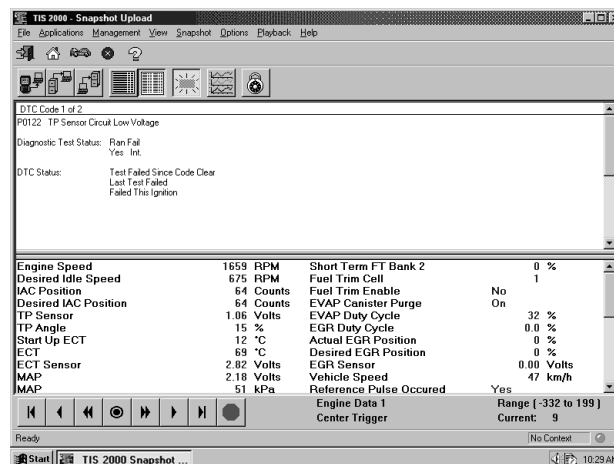

FIGURE 8-43. Viewing DTC Codes on Snapshot Upload Screen

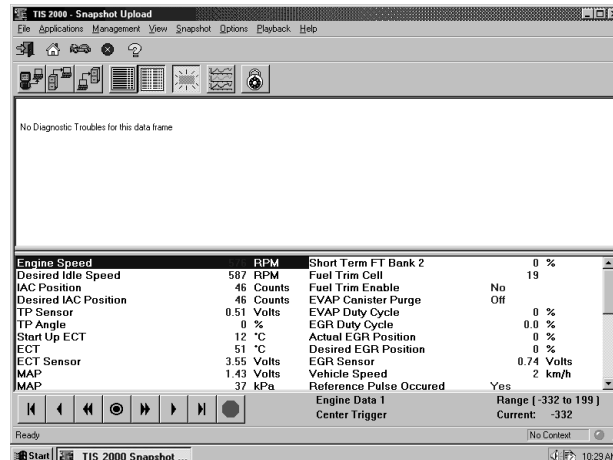

FIGURE 8-44. “No Diagnostic Troubles” Message on DTC Window

## DISPLAYING GRAPHS

A valuable function of snapshot display is the ability to view up to three data parameters in graph form. This allows you to see how a parameter is functioning over time. It also allows easy visual comparison of up to three parameters at a single time.

### To access Display Graph mode:

1. Click on the Display Graph icon (Figure 8-47).  
A Graph Parameters window appears (Figure 8-48).
2. Click on the first graph icon at the top of the graph parameters window, then select a parameter from the list in the lower portion of the box.  
The parameter name appears next to the first graph icon (Figure 8-48).
3. Repeat this procedure for the second and third graphs.

#### NOTE



When selecting parameters to be graphed, consider the values used to measure the parameter to correctly plot these on the graphs. This is done in the Min Y Axis Value and Max Y Axis Value fields. These may need to be adjusted to reflect the normal range of values for the parameter—for example, 0 to 5 volts for MAP sensor.

4. When three desired parameters have been selected, select OK.  
The screen changes to display the chosen parameters in graph form (Figure 8-49).
5. Using the navigation icons, move through the parameters.
6. Click and drag on the arrow along the bottom of each graph to move through the graph (Figure 8-49).  
This arrow represents the current frame being viewed. It is useful for pinpointing precisely when a parameter change indicates a fault.

A data value corresponding to the frame that the arrow is pointing to is displayed in the upper left corner of each graph.

- To select a different parameter to be graphed, simply click and hold on the parameter name in the data list, then drag the cursor over one of the existing graphs and release the mouse button.

The new parameter is graphed in place of the old one.

- To view a graph at full-screen size, move the cursor over the graph. When the cursor changes to a magnifying glass, click on the graph.

The graph appears at full-screen size (Figure 8-50).

- Single click on the full size graph to return to the three-graph display.

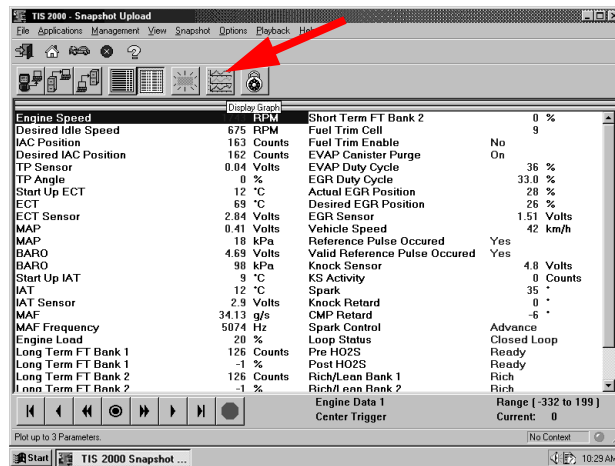

FIGURE 8-45. Display Graph Icon on Snapshot Upload Screen

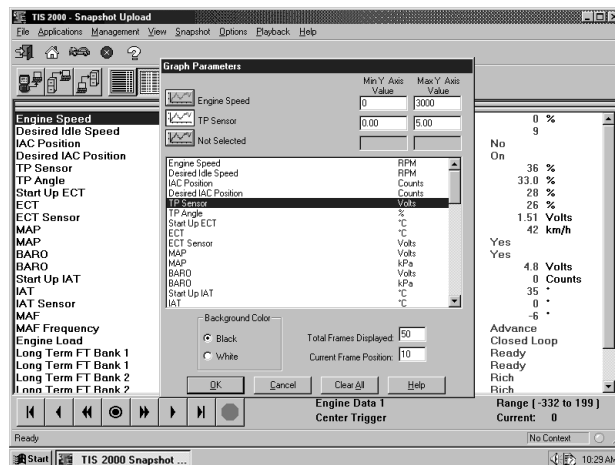

FIGURE 8-46. Graph Parameters Window

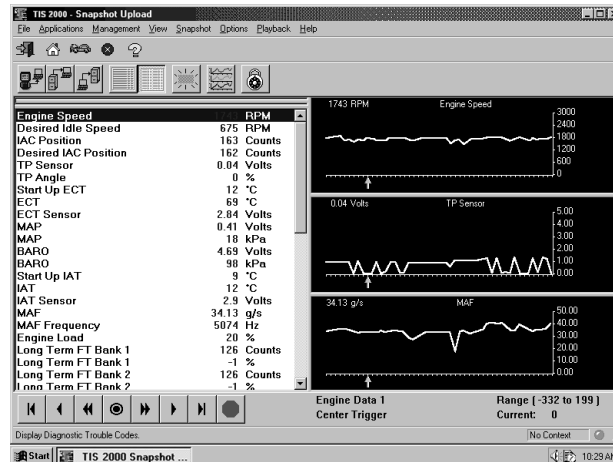

FIGURE 8-47. Three Parameters Shown in Graph Form

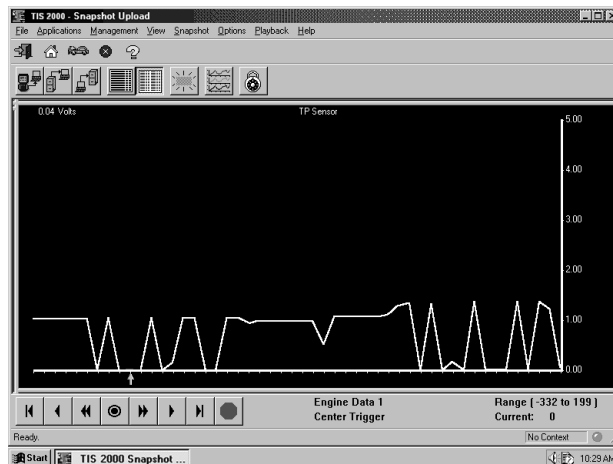

FIGURE 8-48. TP Sensor Parameter Shown in Full-Size Graph

## LOCK/UNLOCK PARAMETERS

The Lock/Unlock Parameters function is used to isolate specific parameters so they can be viewed and compared more easily than if they were part of the larger parameters list.

### To use the Lock/Unlock Parameters function:

1. Click on the desired parameter to highlight it, then click on the Lock/Unlock Parameters icon (Figure 8-51).  
The selected parameter appears at the top of the data list, above a “lock line” (Figure 8-52).
2. To add other parameters, follow the same procedure. The “locked” parameters can then be viewed together to compare their data values. Parameters can also be locked by double-clicking on them in the data list.
3. To remove an item from the locked list, select it, then click the Lock/Unlock icon.

The item is removed from the list.

**TIP!**

In addition to using each display option individually, they can be used in various combinations to provide the most useful diagnostic capability. It is even possible to view DTC information, locked parameters, and graphed parameters simultaneously (Figure 8-53). In multi-display mode, replay buttons can be used, as previously described, to move through the snapshot.

## VIEWING CAPTURE INFO DATA

Capture Info is a feature that allows the Tech 2 to retrieve DTCs, Freeze Frame, and Failure Records from the vehicle's control module. This is a different function than snapshot display. Capture Info files consist of only one frame of data, whereas snapshots typically contain multiple frames of data.

When Capture Info is selected, the scan tool displays a menu selection that allows data from the control module to be stored to the Tech 2 PCMCIA card, or to refresh the PCMCIA card with new data from a control module.

**Important:** A single code may be counted as two different codes in a Capture Info. file if it exists both in freeze frame and failure records (Figure 8-54).

### To view DTCs, Freeze Frame, or Failure Record data through TIS 2000 software:

1. Use the Tech 2 Capture Info function to retrieve data from a vehicle's control module.
2. Connect the Tech 2 to the computer (refer to Figure 8-20).
3. Start TIS 2000.
4. Select the Snapshot Upload application (refer to Figure 8-18).
5. Click on the Upload from Hand-held icon from the toolbar (refer to Figure 8-40).
6. Select Tech 2, then select OK.
7. Select Capture Data from the upload selection menu, then select OK.

The data is displayed on the screen (Figure 8-54). The top of the screen lists DTCs that were stored in the control module. The lower portion of the screen lists captured freeze frame or fail record data for the selected DTC. Notice that the navigation selections at the bottom of the screen are gray. This is because the data record consists of only one frame.

8. If more than one DTC is present, selecting a DTC in the list changes the Data List to match that DTC.
9. Capture Info can be stored and printed by the terminal.

## SAVING A SNAPSHOT TO DISK

If you've opened a file and want to save it, choose the Save Snapshot icon from the toolbar (Figure 8-53). You have the option of saving the file to the terminal's hard drive, to a floppy disk, or to the GM ACCESS file server.

When saving a snapshot, the program automatically identifies the file by vehicle description. This information isn't always enough to describe the snapshot.



To help identify the snapshot, type in descriptive information about the snapshot when saving it. This may include vehicle conditions, DTCs, symptoms, repair order, etc. The next time a file is opened, this information aids in locating the correct file.

## PRINTING A SNAPSHOT

To print a snapshot that is currently displayed on the screen, select the File menu, then Print Screen. This prints only the data parameters displayed on the screen. To print the entire parameter list, you need to scroll down the list, then print again.

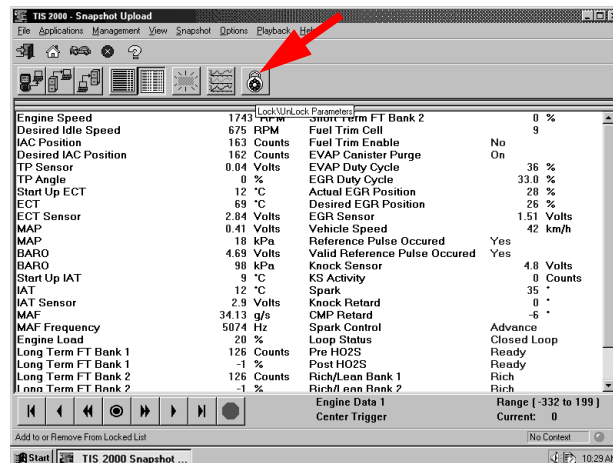

FIGURE 8-49. Lock/Unlock Parameters Icon on SSnapshot Upload Screen

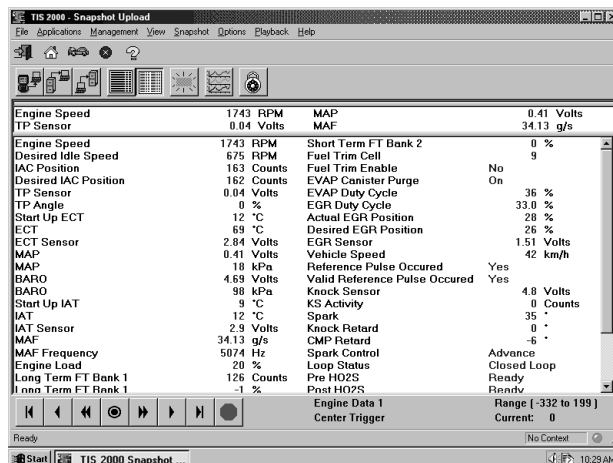

FIGURE 8-50. Snapshot Upload Screen Showing "Locked" List

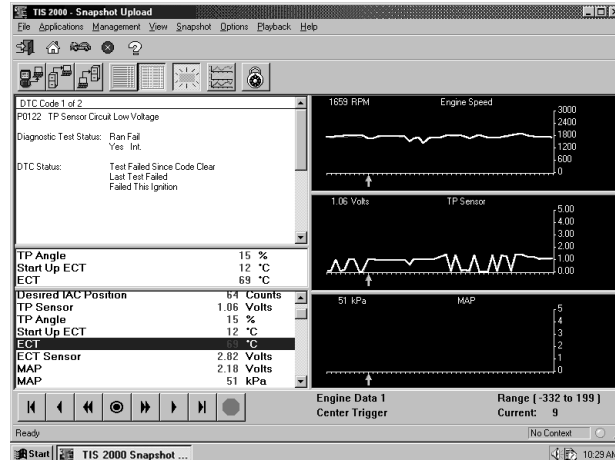

FIGURE 8-51. Multiple Display Modes

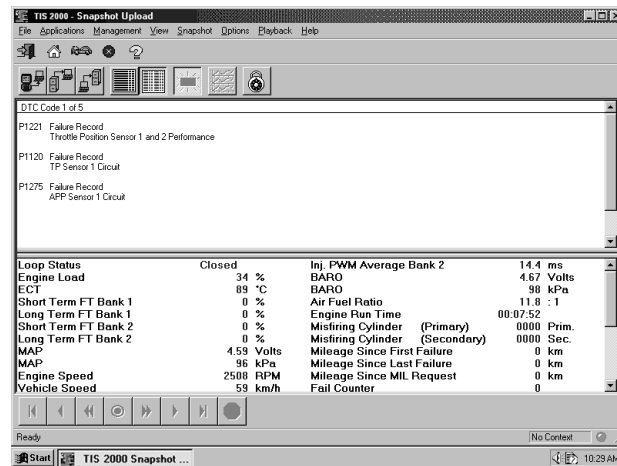

FIGURE 8-52. Viewing Captured Info Data

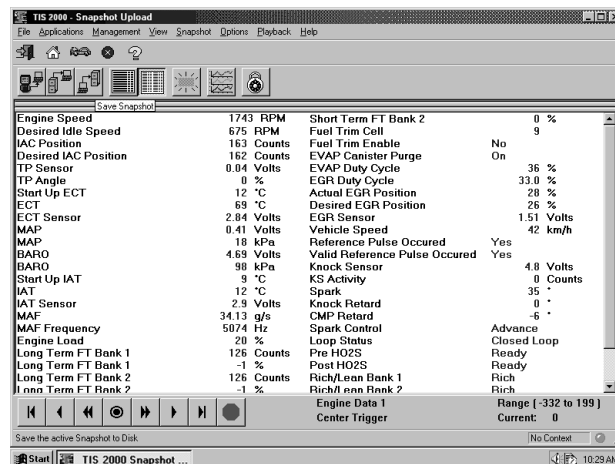

FIGURE 8-53. Save Snapshot Icon on Snapshot Upload Screen

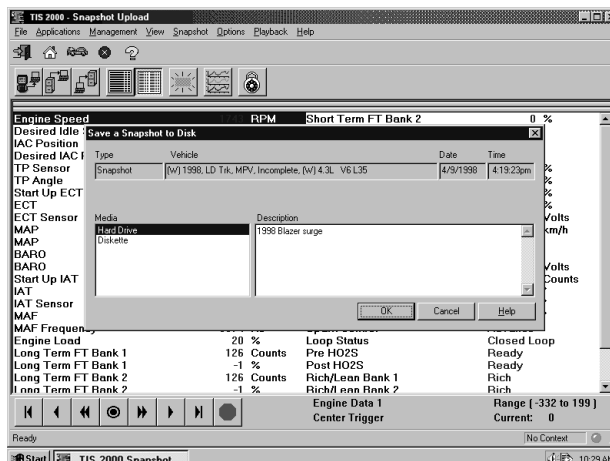

FIGURE 8-54. Save Snapshot Window

## TECH 2 PATHING TABLES

The goal of Pathing Tables is to provide an index and path to help the Tech 2 user find specific vehicle applications/functions. First, the user must enter the basic requirements by selecting the proper Model Year, Vehicle Type, etc. Applications available are based on the specific vehicle selected. The tables are listed in alphabetical order. Identify the application you are looking for and then follow the “path” provided. In most cases the user is searching for data/output controls in the Diagnostic menu. Selections made from the Diagnostic menu include Powertrain, Body, Chassis, and Diagnostic Circuit Checks (where applicable), i.e. Fuel Pump Relay-Special Functions / Engine Output Controls.

## POWERTRAIN PATHING TABLES

### Tech 2 Powertrain Engine Output Controls Pathing Table\*

A/C Clutch	Special Functions / Engine Output Controls
A/C Compressor	Special Functions / Engine Output Controls
A/C Cutoff Relay	Special Functions / Engine Output Controls
A/C Relay	Special Functions / Engine Output Controls
AIR Control Solenoid	Special Functions / Engine Output Controls / Air System
AIR Pump	Special Functions / Engine Output Controls
AIR Pump	Special Functions / Engine Output Controls / AIR System
AIR Pump Relay	Special Functions / Engine Output Controls / AIR System (Refer to Secondary Air Pump Relay)
AIR Solenoid	Special Functions

AIR Solenoid	Special Functions / Engine Output Controls
AIR Solenoid	Special Functions / Engine Output Controls / Air System (Refer to Secondary Air Solenoid Valve)
AIR Switch Solenoid	Special Functions / Engine Output Controls / Air System
AIR System	Special Functions / Engine Output Controls
AIR System	Special Functions / Engine Output Controls
AIR System	Special Functions / Engine Output Controls / Air System
All Relays	Special Functions / Engine Output Controls / Fan Relays
Alternator	Special Functions / Engine Output Controls
Alternator L Terminal	Special Functions / Engine Output Controls
Alternator Lamp	Special Functions / Engine Output Controls / Dash Lamps
Aux. Cooling Fan	Special Functions / Engine Output Controls
Backup Fuel	Special Functions
Backup Spark	Special Functions
Boost Solenoid	Special Functions / Engine Output Controls
Both Fan Controls	Special Functions / Engine Output Controls / Fan Relays
Brake Light	Special Functions / Engine Output Controls / Dash Lamps
C/C Servo	Special Functions / Engine Output Controls / Cruise Control
C/C Vacuum Solenoid	Special Functions / Engine Output Controls / Cruise Control
C/C Vent Solenoid	Special Functions / Engine Output Controls / Cruise Control (Refer to Cruise Control)
Change Oil Lamp	Special Functions / Engine Output Controls / Dash Lamps
Chassis Pitch Signal	Special Functions / Engine Output Controls
Check Mode	Special Functions
Clear Cold Start Counter	Special Functions
Cold Advance Relay	Special Functions / Engine Output Controls
Crankshaft Pos. Variation Learn	Special Functions
Cruise Clutch	Special Functions / Engine Output Controls
Cruise Control	Special Functions / Engine Output Controls
Cruise Enable	Special Functions / Engine Output Controls
Cruise Inhibit	Special Functions / Engine Output Controls
Cruise Lamp	Special Functions / Engine Output Controls / Dash Lamps
Cylinder Power Balance	Special Functions / Engine Output Controls / Injection Pump

\*. For vehicles with DTCs

Dash Lamps & Gauges	Special Functions / Engine Output Controls
Dash Lamps	Special Functions / Engine Output Controls
Dash Lamps	Special Functions / Engine Output Controls / Injection Pump
ECM/Immobilizer Relearn	Special Functions
EGR 1	Special Functions / Engine Output Controls / EGR System
EGR 2	Special Functions / Engine Output Controls / EGR System
EGR 3	Special Functions / Engine Output Controls / EGR System
EGR Bypass Solenoid	Special Functions / Engine Output Controls / EGR System
EGR Solenoid	Special Functions
EGR Solenoid	Special Functions / Engine Output Controls
EGR Solenoid	Special Functions / Engine Output Controls / EGR System
EGR System	Special Functions / Engine Output Controls
EGR Vent	Special Functions / Engine Output Controls / EGR System (Refer to Reset EGR ALM Cells)
Engine Shut Off	Special Functions / Engine Output Controls / Injection Pump
EPR Solenoid	Special Functions / Engine Output Controls
EVAP Canister Vent Valve	Special Functions / Engine Output Controls
EVAP Pressure Switching Solenoid	Special Functions / Engine Output Controls
EVAP Purge Solenoid (PWM)	Special Functions / Engine Output Controls
EVAP Purge Solenoid (PWM)	Special Functions / Engine Output Controls / EVAP System
EVAP Purge Solenoid	Special Functions / Engine Output Controls
EVAP Purge Solenoid	Special Functions / Engine Output Controls / EVAP System
EVAP Purge Valve	Special Functions / Engine Output Controls
EVAP Purge/Seal	Special Functions / Engine Output Controls / EVAP System
EVAP System	Special Functions / Engine Output Controls
EVAP System Perf.	Special Functions / Engine Output Controls / EVAP System
EVAP System Seal	Special Functions / Engine Output Controls / EVAP System
EVAP Vent Solenoid	Special Functions / Engine Output Controls
EVAP Vent Solenoid	Special Functions / Engine Output Controls / EVAP System
EVO	Special Functions / Engine Output Controls
Fan Control A10	Special Functions / Engine Output Controls / Fan Relays
Fan Control A11	Special Functions / Engine Output Controls / Fan Relays (Refer to Both Fan Controls)
Fan High Speed	Special Functions / Engine Output Controls / Fan Relays

Fan Low Speed	Special Functions / Engine Output Controls / Fan Relays
Fan Relay	Special Functions / Engine Output Controls
Fan Relay 1	Special Functions / Engine Output Controls / Fan Relays
Fan Relay 2	Special Functions / Engine Output Controls / Fan Relays (Refer to High Fan Relay)
Fan Relay ECM C6	Special Functions / Engine Output Controls / Fan Relays
Fan Relay ECM D11	Special Functions / Engine Output Controls / Fan Relays
Fan Relays (Both)	Special Functions / Engine Output Controls / Fan Relays
Fan Relays 1, 2, & 3	Special Functions / Engine Output Controls / Fan Relays
Fan Relays 2 & 3	Special Functions / Engine Output Controls / Fan Relays (Refer to All Relays) (Refer to both Fan Controls) (Refer to Low Fan Relay) (Refer to Low Speed Relay Only)
First Gear Start	Special Functions / Engine Output Controls
Fixed Spark	Special Functions / Engine Output Controls
FPR Solenoid	Special Functions / Engine Output Controls
Fuel Gauge	Special Functions / Engine Output Controls
Fuel Pump	Special Functions / Engine Output Controls (Refer to Secondary Fuel Pump)
Fuel Pump Relay	Special Functions / Engine Output Controls
Fuel Pump Speed	Special Functions / Engine Output Controls
Fuel System Prime	Special Functions
Fuel Tank Pressure Valve	Special Functions / Engine Output Controls / EVAP System
Fuel Trim Reset	Special Functions
GEN	Special Functions / Engine Output Controls / Dash Lamps
GEN L Terminal	Special Functions / Engine Output Controls
Glow Plug	Special Functions / Engine Output Controls
Governor	Special Functions / Engine Output Controls
Governor Light	Special Functions / Engine Output Controls / Dash Lamps
High Fan Relay	Special Functions / Engine Output Controls / Fan Relays
Hot Lamp	Special Functions / Engine Output Controls / Dash Lamps
IAC Reset	Special Functions / Engine Output Controls / IAC System
IAC System	Special Functions / Engine Output Controls
Idle Air Control	Special Functions / Engine Output Controls
Idle Air Control	Special Functions / Engine Output Controls / IAC System

Ignition Coil Test #1, #4	Special Functions / Engine Output Controls
Ignition Coil Test #1, #4	Special Functions / Engine Output Controls / Ignition System
Ignition Coil Test #2, #3	Special Functions / Engine Output Controls / Ignition System
Ignition Coil Test #2, #5	Special Functions / Engine Output Controls
Ignition Coil Test #3, #6	Special Functions / Engine Output Controls
Ignition System	Special Functions / Engine Output Controls
Injection Module	Special Functions / Engine Output Controls / Secondary Port System
Injection Pump	Special Functions / Engine Output Controls
Injector # 1	Special Functions / Engine Output Controls
Injector # 2	Special Functions / Engine Output Controls
Injector # 3	Special Functions / Engine Output Controls
Injector # 4	Special Functions / Engine Output Controls
Injector # 5	Special Functions / Engine Output Controls
Injector # 6	Special Functions / Engine Output Controls
Injector Test	Special Functions / Engine Output Controls / Fuel System
Intake Plenum Switch Valve	Special Functions / Engine Output Controls
Intake Resonance Switch Valve	Special Functions / Engine Output Controls
Intercooler	Special Functions / Engine Output Controls
ISC Actuator	Special Functions / Engine Output Controls
ISC Calibrated Air	Special Functions
ITV Relay	Special Functions / Engine Output Controls
Loop Status	Special Functions / Engine Output Controls
Low Coolant Lamp	Special Functions / Engine Output Controls / Dash Lamps
Low Fan Relay	Special Functions / Engine Output Controls / Fan Relays
Low Oil Lamp	Special Functions / Engine Output Controls / Dash Lamps
Low Speed Relay Only	Special Functions / Engine Output Controls / Fan Relays
Malfunction Indicator Lamp (MIL)	Special Functions / Engine Output Controls
Malfunction Indicator Lamp (MIL)	Special Functions / Engine Output Controls / Dash Lamps
Misfire Graphic	Special Functions
O2S System	Special Functions
OBD System Check	Special Functions
Odometer Reset	Special Functions / Engine Output Controls
Oil Level Lamp	Special Functions / Engine Output Controls / Dash Lamps

Oil Life Lamp	Special Functions / Engine Output Controls / Dash Lamps (Refer to Low Oil Lamp) (Refer to Change Oil Lamp)
Oil Life Reset	Special Functions / Engine Output Controls
Oil Pressure Lamp	Special Functions / Engine Output Controls / Dash Lamps
Output Driver U8 Fault Test	Special Functions / Engine Output Controls / Output Drivers
Output Driver U9 Fault Test	Special Functions / Engine Output Controls / Output Drivers
Output Drivers	Special Functions / Engine Output Controls
PCM Integrity Status	Special Functions / Engine Output Controls
QDM A Test — DTC 26	Special Functions
QDM B Test — DTC 56	Special Functions
QDM TEST	Special Functions
Radiator Fan	Special Functions / Engine Output Controls
Reset Block Learn Cells	Special Functions / Engine Output Controls / Fuel System
Reset EGR ALM Cells	Special Functions / Engine Output Controls / EGR System
Reverse Inhibit	Special Functions / Engine Output Controls
Ride Control	Special Functions / Engine Output Controls
RPM Control	Special Functions
1 to 4 Shift Lamp	Special Functions / Engine Output Controls / Dash Lamps
1 to 4 Shift Solenoid	Special Functions / Engine Output Controls
Secondary AIR Pump Relay	Special Functions / Engine Output Controls
Secondary AIR Solenoid Valve	Special Functions / Engine Output Controls
Secondary Fuel Pump	Special Functions / Engine Output Controls / Secondary Port System
Secondary Inlet Solenoid	Special Functions / Engine Output Controls / Secondary Port System
Secondary Port System	Special Functions / Engine Output Controls
Service Spark Retard Reset	Special Functions / Engine Output Controls
Shift Light	Special Functions / Engine Output Controls
Shift Light	Special Functions / Engine Output Controls / Dash Lamps
Skip shift Lamp	Special Functions / Engine Output Controls / Dash Lamps
Skip Shift Solenoid	Special Functions / Engine Output Controls
SMCC Disable	Special Functions / Engine Output Controls
SP/High Speed Relays Only	Special Functions / Engine Output Controls / Fan Relays
Spark Retard	Special Functions / Engine Output Controls (Refer to Service Spark Retard Reset)
Starter Inhibit	Special Functions / Engine Output Controls



---

STS Lamp	Special Functions / Engine Output Controls / Dash Lamps
Tachometer Control	Special Functions / Engine Output Controls
TCC / 1—4 Solenoid	Special Functions / Engine Output Controls
TCC / Shift Light	Special Functions / Engine Output Controls
TCC Solenoid	Special Functions / Engine Output Controls
TDC Learn	Special Functions / Engine Output Controls / Injection Pump
Time Set	Special Functions / Engine Output Controls / Injection Pump
Transfer Case	Special Functions
Upshift Lamp	Special Functions / Engine Output Controls
Upshift Lamp	Special Functions / Engine Output Controls / Dash Lamps & Gauges
Wastegate	Special Functions / Engine Output Controls

## TECH 2 POWERTRAIN TRANSMISSION CONTROLS PATHING TABLE\*

Check Transmission Lamp	Special Functions / Transmission Output Controls
Clear TAPS	Special Functions / Transmission Output Controls
Economy / Sport	Special Functions / Transmission Output Controls / Lamp Controls
Engage TCC	Special Functions / Transmission Output Controls
Engine Overrun Warning	Special Functions / Transmission Output Controls
Exhaust Brake Cut	Special Functions / Transmission Output Controls
Garage Shift	Special Functions / Transmission Output Controls / Reset Adapts
Lamp Controls	Special Functions / Transmission Output Controls
Learn TAPS	Special Functions / Transmission Output Controls
Line Pressure Duty Solenoid	Special Functions / Transmission Output Controls
Lockup Duty Solenoid	Special Functions / Transmission Output Controls
Neutral Solenoid	Special Functions / Transmission Output Controls / Solenoid Controls
Oil Life Reset	Special Functions / Transmission Output Controls
P/N Info To ECM	Special Functions / Transmission Output Controls
Park Neutral Switch Test	Special Functions / Transmission Output Controls
PC Solenoid	Special Functions / Transmission Output Controls
Power Control Relay	Special Functions / Transmission Output Controls
Pressure Regulator Solenoid	Special Functions / Transmission Output Controls / Solenoid Controls
PTO Solenoid	Special Functions / Transmission Output Controls
Reset Adapts	Special Functions / Transmission Output Controls
Reset Learned Values	Special Functions / Transmission Output Controls / Resets
Reset TC TPS Status	Special Functions / Transmission Output Controls / Resets
Resets	Special Functions / Transmission Output Controls
1-2 / 3-4 Shift Solenoid	Special Functions / Transmission Output Controls
1-2 / 3-4 Shift Solenoid	Special Functions / Transmission Output Controls / Solenoid Controls
1-2 Solenoid	Special Functions / Transmission Output Controls
2-3 Shift Solenoid	Special Functions / Transmission Output Controls / Solenoid Controls
2-3 Solenoid	Special Functions / Transmission Output Controls
2nd Gear Start Lamp	Special Functions / Transmission Output Controls
3-2 Downshift Solenoid	Special Functions / Transmission Output Controls
Shift	Special Functions / Transmission Output Controls / Reset Adapts

Shift Solenoid 1	Special Functions / Transmission Output Controls
Shift Solenoid 2	Special Functions / Transmission Output Controls
Shift Solenoid A	Special Functions / Transmission Output Controls
Shift Solenoid B	Special Functions / Transmission Output Controls
Shift Transmission	Special Functions / Transmission Output Controls
Solenoid Controls	Special Functions / Transmission Output Controls
Sport Mode Lamp	Special Functions / Transmission Output Controls
Steady State	Special Functions / Transmission Output Controls / Reset Adapts
Steady State	Special Functions / Transmission Output Controls / Reset Adapts
STL	Special Functions / Transmission Output Controls
TCC Apply Solenoid	Special Functions / Transmission Output Controls
TCC Control Solenoid	Special Functions / Transmission Output Controls
TCC Enable	Special Functions / Transmission Output Controls
TCC PWM Solenoid	Special Functions / Transmission Output Controls
TCC Solenoid	Special Functions / Transmission Output Controls
Torque Control Solenoid	Special Functions / Transmission Output Controls / Solenoid Controls
Transfer Case	Special Functions
Transmission Output Controls	Special Functions
VCC Solenoid	Special Functions / Transmission Output Controls
Warning Cut	Special Functions / Transmission Output Controls
Winter LED	Special Functions / Transmission Output Controls / Lamp Controls
Winter Mode Lamp	Special Functions / Transmission Output Controls
WOT 1-2	Special Functions / Transmission Output Controls / Reset Adapts

## Tech 2 Fuel System Pathing Table\*

Cylinder Power Balance	Special Functions / Fuel System
Fuel Economy Test	Special Functions / Fuel System
Fuel Injector Balance	Special Functions / Fuel System
Fuel Injector Modification	Special Functions / Fuel System
Fuel System	Special Functions
Fuel Trim Enable	Special Functions / Fuel System
Fuel Trim Reset	Special Functions

\*. For vehicles with DTCs

Fuel Trim Reset	Special Functions / Fuel System
Injector Fault Reset	Special Functions / Fuel System
RPM Control	Special Functions / Fuel System

### Tech 2 ATC Controls Table\*

2WD High Indicator Light	Special Functions / ATC Output Controls
4WD High Indicator Light	Special Functions / ATC Output Controls
4WD Low Indicator Light	Special Functions / ATC Output Controls
ATC Motor A Control	Special Functions / ATC Output Controls
ATC Motor B Control	Special Functions / ATC Output Controls
Auto 4WD Indicator Light	Special Functions / ATC Output Controls
Engage Front Axle	Special Functions / ATC Output Controls
Mode Switch	Special Functions / ATC Output Controls
Neutral Indicator Light	Special Functions / ATC Output Controls
Service 4WD Lamp	Special Functions / ATC Output Controls
Transfer Case Lock	Special Functions / ATC Output Controls

### Tech 2 IAC System Pathing Table\*

IAC Calibration	Special Functions / IAC System
IAC Reset	Special Functions / IAC System
Idle Learn	Special Functions / IAC System
RPM Control	Special Functions / IAC System

### Tech 2 ISC System Pathing Table\*

ISC Extend	Special Functions / ISC System
ISC Retract	Special Functions / ISC System
ISC System	Special Functions
RPM Control	Special Functions / ISC System
TPS/Idle Learn	Special Functions / ISC System

### Tech 2 TAC System Pathing Table\*

Engine Speed Control	Special Functions / TAC System
----------------------	--------------------------------

\*. For vehicles with DTCs

## Tech 2 Service Bay Tests Table\*

EVAP Test	Special Function / Service Bay Tests
-----------	--------------------------------------

## Tech 2 Powertrain (Bi-Fuel) Engine Output Controls Pathing Table\*

A/C Relay	Special Functions (Natural Gas) / Engine Output Controls
Cruise Enable	Special Functions (Natural Gas) / Engine Output Controls
EGR Solenoid	Special Functions (Natural Gas) / Engine Output Controls
Engine Output Controls	Special Functions (Natural Gas)
EVAP Purge Solenoid (PWM)	Special Functions (Nature Gas) / Engine Output Controls
EVAP Purge Solenoid	Special Functions (Nature Gas) / Engine Output Controls / EVAP System
EVAP Purge/Seal	Special Functions (Natural Gas) / Engine Output Controls / EVAP System
EVAP System	Special Functions (Natural Gas) / Engine Output Controls
EVAP System Perf.	Special Functions (Natural Gas) / Engine Output Controls / EVAP System
EVAP System Seal	Special Functions (Natural Gas) / Engine Output Controls / EVAP System
EVAP Vent Solenoid	Special Functions (Natural Gas) / Engine Output Controls / EVAP System
Fan Relay	Special Functions (Natural Gas) / Engine Output Controls
Fuel Pump	Special Functions (Natural Gas) / Engine Output Controls
GEN L Terminal	Special Functions (Natural Gas) / Engine Output Controls
Loop Status	Special Functions (Natural Gas) / Engine Output Controls
Malfunction Indicator Lamp (MIL)	Special Functions (Natural Gas) / Engine Output Controls
Tech 2 (Bi	Fuel) IAC System Pathing Table *
RPM Control	Special Functions (Natural Gas) / IAC System
Tech 2 Powertrain (Electric) Engine Output Controls Pathing Table	
Auto Disconnect Functional Test	Special Functions / BPCM Output Controls
Battery Life Lamp	Special Functions / BPCM Output Controls
Battery Pack Discharge Test	Special Functions / BPCM Output Controls
Battery Pack Voltage Gauge	Special Functions / BPCM Output Controls
Battery Thermal Cool Test	Special Functions / BPCM Output Controls
Battery Thermal Heat Test	Special Functions / BPCM Output Controls
BPMC Output Controls	Special Functions
Power Use Gauge	Special Functions / BPCM Output Controls

\*. For vehicles with DTCs

Service Now Lamp	Special Functions / BPCM Output Controls
Service Soon Lamp	Special Functions / BPCM Output Controls
State of Charge Gauge	Special Functions / BPCM Output Controls

## BODY PATHING TABLE

### Tech 2 Body Diagnostics Pathing Table

A/C Clutch	Heating and Air Conditioning / Special Functions / Output Tests
A/C Defrost Solenoid	Heating and Air Conditioning / Special Functions / Output Control / Solenoid Test
A/C Mix Door	Heating and Air Conditioning / Special Functions / Output Tests
A/C Request	Instrument Panel Module / Special Functions / Miscellaneous Test
A/C Request Signal Test	Heating and Air Conditioning / Special Functions
ABS Lamp	Instrument Panel Cluster / Special Functions / Lamp Test
Air Circulation Valve Test	Heating and Air Conditioning / Special Functions
Air Down Solenoid	Heating and Air Conditioning / Special Functions / Output Control / Solenoid Test
Air Inlet Door	Heating and Air Conditioning / Special Functions / Output Tests
Air Inlet Door Position	Heating and Air Conditioning / Special Functions / HVAC Motors
Air Inlet Door Position	Instrument Panel Module / Special Functions / HVAC Motors
Air Up Solenoid	Heating and Air Conditioning / Special Functions / Output Control / Solenoid Test
Alarm Warning	Remote Function Actuation / Special Functions / Output Control (Refer to Clear Alarm Information)
ALC Headlamps	Body Function Controller / Special Functions / Output Control
ALC Parking Lamps	Body Function Controller / Special Functions / Output Control
ALDL PIN 14 Wired Information	Entertainment & Comfort Bus
All Doors Unlock	Body Control Module / Special Functions / Output Control / Door Lock Test
Ambient Temperature	Heating and Air Conditioning / Special Functions / Output Control
Antenna	Radio / Special Functions / Output Control
Automatic Door Lock Mode	Onstar / Personalization / Set Options
Auxiliary Heater Test	HTCM / Special Functions
Battery Life Lamp	Instrument Panel Cluster / Special Functions / Lamp Test
Battery Pack Fan Test	HTCM / Special Functions
Battery Pack Primary Valve Test	HTCM / Special Functions

Battery Pack Secondary Valve Test	HTCM / Special Functions
BCM Reprogramming	Body Control Module / Special Functions
Blower Motor	Instrument Panel Module / Special Functions / Miscellaneous Test
Blower Motor Test	Heating and Air Conditioning / Special Functions
Blower Motor	Heating and Air Conditioning / Special Functions / Output Control / Miscellaneous Test
Blower Speed	Heating and Air Conditioning / Special Functions / Output Control
Brake Lamp	Instrument Panel Cluster / Special Functions / Lamp Test
Brake to Shift Relay	Body Control Module / Special Functions / Output Control
Brake to Shift Relay	Rear Integration Module / Special Functions / Output Control
Brake to Shift Telltale	Body Control Module / Special Functions / Output Control / Miscellaneous Test
Charge Lamp	Instrument Panel Cluster / Special Functions / Lamp Test
Charge LED	Instrument Panel Cluster / Special Functions / Lamp Test
Charge Receptacle Valve Test	HTCM / Special Functions
Check Gauges Lamp	Instrument Panel Cluster / Special Functions / Lamp Test
Chime	Body Function Controller / Special Functions / Output Control
Chime	Instrument Panel Cluster / Special Functions / Chime Test
Chime Fast	Instrument Panel Cluster / Special Functions / Chime Test
Chime Medium	Instrument Panel Cluster / Special Functions / Chime Test
Chime Slow	Instrument Panel Cluster / Special Functions / Chime Test
Chime Test	Body Control Module / Special Functions / Output Control
Cigar Lighter	Rear Integration Module / Special Functions / Output Control
Clear Alarm Information	Body Control Module / Special Functions / Output Control / Miscellaneous Test
Clear Manufacturer Enable Counter	Vehicle Theft Deterrent / Special Functions
Component Identification	Entertainment & Comfort Bus
Compressor Test	Heating and Air Conditioning / Special Functions
Control Power	Dash Integration Module / Special Functions / Output Control
Coolant Gauge Sweep	Instrument Panel Cluster / Special Functions / Output Control
Coolant Gauge Sweep Test	Instrument Panel Cluster / Special Functions / IPC Gauges
Courtesy Lamps	Remote Function Actuation / Special Functions / Output Control
Cruise Lamp	Instrument Panel Cluster / Special Functions / Lamp Test
Cycle Speakers	Radio / Special Functions / Output Control / Front Speakers
Daytime Running Lamps	Body Control Module / Special Functions / Output Control / Light Test

Daytime Running Lamps	Body Function Controller / Special Functions / Output Control
Daytime Running Lamps	Dash Integration Module / Special Functions / Output Control
Defrost Air Mix Door Motor Test	Heating and Air Conditioning / Special Functions
Defrost/Heater Door	Heating and Air Conditioning / Special Functions / Output Tests
Deice Enable	Instrument Panel Cluster / Special Functions / Output Control
Delay Accessory Bus	Body Control Module / Special Functions / Output Control / Miscellaneous Test
Delay interior Lights	Body Control Module / Special Functions / Output Control / Light Test
Delayed Headlamp Illumination Mode	Onstar / Personalization / Set Options
Device Enable	Instrument Panel Cluster / Special Functions / Output Control
Disable DRL	Instrument Panel Cluster / Special Functions / IPC Options
Display Test	Heating and Air Conditioning / Special Functions
Display Key Cylinder Number	Immobilizer / Special Functions
Display VIN	Immobilizer / Special Functions
Dolby	Radio / Special Functions / Output Control
Dolby N.R.	Radio / Special Functions / Set Options
Door Backlight Test	Left Door Control Module / Special Functions / Output Control
Door Backlight Test	Right Door Control Module / Special Functions / Output Control
Door Lock	Body Control Module / Special Functions / Output Control / Door Lock Test
Door Lock	Remote Function Actuation / Special Functions / Output Control
Door Lock Test	Body Control Module / Special Functions / Output Control
Door Lock Test	Driver Door Module / Special Functions / Output Control
Door Lock Test	Left Door Control Module / Special Functions / Output Control
Door Lock Test	Right Door Control Module / Special Functions / Output Control
Door Unlock	Remote Function Actuation / Special Functions / Output Control (Refer to All Doors Unlock) (Refer to Last Door Closed Locking Mode) (Refer to Automatic Door Lock Mode) (Refer to Remote Unlock Verification Mode) (Refer to Remote Lock Verification Mode)
Door Window Test	Driver Door Module / Special Functions / Output Control
Door Window Test	Left Door Control Module / Special Functions / Output Control
Door Window Test	Right Door Control Module / Special Functions / Output Control
Drive	Instrument Panel Cluster / Special Functions / PRNDL Display
Driver #1 Activation Verification	Onstar / Personalization / Set Options
Driver #1 Auto Exit Seat	Onstar / Personalization / Set Options



Driver #1 Auto Exit Steering Wheel	Onstar / Personalization / Set Options
Driver #1 Automatic Door Lock Mode	Onstar / Personalization / Set Options
Driver #1 Curb View	Onstar / Personalization / Set Options
Driver #1 Key Fob Options	Onstar / Personalization / Driver Information Center / Driver #1
Driver #1 Memory Recall	Onstar / Personalization / Set Options
Driver #1 Name	Onstar / Personalization / Driver Information Center / Driver #1
Driver #1 Name	Personalization / Driver Information Center
Driver #1 Perimeter Lighting	Onstar / Personalization / Set Options
Driver #2 Activation Verification	Onstar / Personalization / Set Options
Driver #2 Auto Exit Seat	Onstar / Personalization / Set Options
Driver #2 Auto Exit Steering Wheel	Onstar / Personalization / Set Options
Driver #2 Automatic Door Lock Mode	Onstar / Personalization / Set Options
Driver #2 Curb View	Onstar / Personalization / Set Options
Driver #2 Key Fob Options	Onstar / Personalization / Driver Information Center / Driver #2
Driver #2 Memory Recall	Onstar / Personalization / Set Options
Driver #2 Name	Onstar / Personalization / Driver Information Center / Driver #2
Driver #2 Name	Personalization / Driver Information Center
Driver #2 Perimeter Lighting	Onstar / Personalization / Set Options
Driver #3 & 4 Activation Verification	Onstar / Personalization / Set Options
Driver #3 & 4 Key Fob Options	Onstar / Personalization / Driver Information Center / Driver #3 & 4
Driver #3 & 4 Perimeter Lighting	Onstar / Personalization / Set Options
Driver Door Relay	Remote Function Actuation / Special Functions / Output Control
Driver Door Unlock	Body Control Module / Special Functions / Output Control / Door Lock Test
Driver Mirror Down	Memory Mirror Module / Special Functions / Output Control
Driver Mirror Left	Memory Mirror Module / Special Functions / Output Control
Driver Mirror Right	Memory Mirror Module / Special Functions / Output Control
Driver Mirror Up	Memory Mirror Module / Special Functions / Output Control
DRL Option	Instrument Panel Cluster / Special Functions / IPC Options
DRL Relay Test	Instrument Panel Cluster / Special Functions
E & C Control	Entertainment & Comfort Bus
ECM/Immobilizer Relearn	Immobilizer / Special Functions
Electronic Serial Number	Cellular Telephone / Special Functions

Enable Radio for Cell Phone	Entertainment & Comfort Bus / Special Functions
Engine Hot Lamp	Instrument Panel Cluster / Special Functions / Lamp Test
Erase Transponder Keys	Immobilizer / Special Functions
Exterior Lamps	Body Control Module / Special Functions / Output Control / Light Test
Exterior Lamps	Remote Function Actuation / Special Functions / Output Control
1st	Instrument Panel Cluster / Special Functions / PRNDL Display
Floor Air Mix Door Motor Test	Heating and Air Conditioning / Special Functions
Fob #1 Mirrors	Personalization / Set Options
Fob #1 Option #1	Personalization / Set Options
Fob #1 Option #1	Remote Function Actuation / Special Functions / Set Options
Fob #1 Option #2	Personalization / Set Options
Fob #1 Option #2	Remote Function Actuation / Special Functions / Set Options
Fob #1 Option #3	Personalization / Set Options
Fob #1 Option #3	Remote Function Actuation / Special Functions / Set Options
Fob #1 Windows	Personalization / Set Options
Fob #2 Mirrors	Personalization / Set Options
Fob #2 Option #1	Personalization / Set Options
Fob #2 Option #1	Remote Function Actuation / Special Functions / Set Options
Fob #2 Option #2	Personalization / Set Options
Fob #2 Option #2	Remote Function Actuation / Special Functions / Set Options
Fob #2 Option #3	Personalization / Set Options
Fob #2 Option #3	Remote Function Actuation / Special Functions / Set Options
Fob #2 Windows	Personalization / Set Options (Refer to Programmable FOBS)
Front Courtesy Light	Rear Integration Module / Special Functions / Output Control
Front Down & Seat Reverse	Memory Seat Module / Special Functions / Output Control
Front Down	Seat Control Module / Special Functions / Output Control
Front End Fan Test	HTCM / Special Functions
Front Fog Lamps	Dash Integration Module / Special Functions / Output Control
Front Speakers	Amplifier (Bose) / Special Functions / Output Control
Front Speakers	Amplifier (Delco) / Special Functions / Output Control
Front Speakers	Radio / Special Functions / Output Control
Front Up	Memory Seat Module / Special Functions / Output Control
Front Up	Seat Control Module / Special Functions / Output Control

Front Up/Down	Memory Seat Module / Special Functions / Output Control
Fuel Door Release	Body Control Module / Special Functions / Output Control / Miscellaneous Test
Fuel Door Release Relay	Rear Integration Module / Special Functions / Output Control
Fuel Gauge Sweep	Instrument Panel Cluster / Special Functions / Output Control
Fuel Gauge Sweep Test	Instrument Panel Cluster / Special Functions / IPC Gauges
Gage Setup	Instrument Panel Cluster / Special Functions / Set Options
Gauge Setup	Onstar / Personalization / Set Options
Head Lamps Require Telltale	Body Control Module / Special Functions / Output Control / Miscellaneous Test (Refer to Delay Headlamp Illumination Mode)
Headrest Up/Down	Memory Seat Module / Special Functions / Output Control
Heated Seat	Body Control Module / Special Functions / Output Control
Heated Seat	Rear Integration Module / Special Functions / Output Control (Refer to Auxiliary Heater Test)
Heating Cutoff Valve Test	Heating and Air Conditioning / Special Functions
High Beam Lamp	Instrument Panel Cluster / Special Functions / Lamp Test
High Beam Relay	Dash Integration Module / Special Functions / Output Control
High Beams	Body Control Module / Special Functions / Output Control / Light Test
Horn	Body Control Module / Special Functions / Output Control / Miscellaneous Test
Horn	Remote Function Actuation / Special Functions / Output Control
Horn Relay	Dash Integration Module / Special Functions / Output Control
HTR/DEF/AC Door Position	Heating and Air Conditioning / Special Functions / HVAC Motors
HTR/Def/AC Door Position	Instrument Panel Module / Special Functions / HVAC Motors
HVAC Recalibration	Heating and Air Conditioning / Special Functions / Output Control / Miscellaneous Test
Inadvertent Power	Body Control Module / Special Functions / Output Control
Inadvertent Power	Body Function Controller / Special Functions / Output Control
Inadvertent Power Relay	Rear Integration Module / Special Functions / Output Control
Inadvertent Test	Body Control Module / Special Functions / Output Control
Incand. Dim #1 Enable	Instrument Panel Cluster / Special Functions / Output Control
Incand. Dim #1	Instrument Panel Cluster / Special Functions / Output Control
Incand. Dim #2 Enable	Instrument Panel Cluster / Special Functions / Output Control
Incand. Dim #2	Instrument Panel Cluster / Special Functions / Output Control
Incandescent Dimming	Dash Integration Module / Special Functions / Output Control

Incandescent Dimming	Instrument Panel Cluster / Special Functions / Output Control
Instant OAT Update	Heating and Air Conditioning / Special Functions / Output Control / Miscellaneous Test
Instant OAT Update	Instrument Panel Module / Special Functions / Miscellaneous Test
Interior Air Mix Door Motor Test	Heating and Air Conditioning / Special Functions
Interior Lamps	Body Control Module / Special Functions / Output Control / Light Test
Interior Lamps	Body Function Controller / Special Functions / Output Control
IPC Options	Instrument Panel Cluster / Special Functions
IPM Recalibration	Instrument Panel Module / Special Functions / Miscellaneous Test
Key Fobs Function Test	Body Control Module / Special Functions
Key Light (Halo)	Instrument Panel Module / Special Functions / Miscellaneous Test
Key Test	Driver Door Module / Special Functions
Key Test	Driver Information Center / Special Functions
Language	Instrument Panel Cluster / Special Functions / Set Options
Language	Onstar / Personalization / Set Options
Last Door Closed Locking Mode	Onstar / Personalization / Set Options
Left Air Mix Door Motor Test	Heating and Air Conditioning / Special Functions
Left and Right Mirror Test	Driver Door Module / Special Functions / Output Control
Left Front Midrange	Radio / Special Functions / Output Control / Front Speakers
Left Front Tweeter	Radio / Special Functions / Output Control / Front Speakers
Left Rear Subwoofer	Radio / Special Functions / Output Control / Rear Speakers
Left Temp Door Position	Heating and Air Conditioning / Special Functions / HVAC Motors
Left Temp Door Position	Instrument Panel Module / Special Functions / HVAC Motors
Light Test	Body Control Module / Special Functions / Output Control
Lighting for Theft	Dash Integration Module / Special Functions / Output Control
Load Management Option	Body Control Module / Special Functions / Set Options
Low Beam Relay	Dash Integration Module / Special Functions / Output Control
Low Beams	Body Control Module / Special Functions / Output Control / Light Test
Low Fuel Lamp	Instrument Panel Cluster / Special Functions / Lamp Test
Low Washer Fluid	Instrument Panel Cluster / Special Functions / Lamp Test
Lower Motor	Heating and Air Conditioning / Special Functions / Output Control / Miscellaneous Test
Lumbar Down & Lumbar Back	Memory Seat Module / Special Functions / Output Control
Lumbar Forward	Memory Seat Module / Special Functions / Output Control

Lumbar Forward/Backward	Memory Seat Module / Special Functions / Output Control
Lumbar Up	Memory Seat Module / Special Functions / Output Control
Lumbar Up/Down	Memory Seat Module / Special Functions / Output Control
Military Time or Standard Time	Navigation Module / Special Functions / Set Options
Military Time or Standard Time	Radio / Special Functions / Set Options
Mirror Test	Left Door Control Module / Special Functions / Output Control
Mirror Test	Right Door Control Module / Special Functions / Output Control
Miscellaneous Options #1	Dash Integration Module / Special Functions / Set Options
Miscellaneous Options #2	Dash Integration Module / Special Functions / Set Options
Miscellaneous Test	Body Control Module / Special Functions / Output Control
Miscellaneous Test	Heating and Air Conditioning / Special Functions / Output Control
Mix Door #1	Heating and Air Conditioning / Special Functions / Output Tests
Mix Door #2	Heating and Air Conditioning / Special Functions / Output Tests
Neutral	Instrument Panel Cluster / Special Functions / PRNDL Display
New VIN	Dash Integration Module / Special Functions
Odometer Display	Instrument Panel Cluster / Special Functions / Lamp Test
Odometer Reading	Instrument Panel Cluster / Special Functions
Oil Gauge Sweep Test	Instrument Panel Cluster / Special Functions / IPC Gauges
Oil Pressure Lamp	Instrument Panel Cluster / Special Functions / Lamp Test
Option #0	Personalization / Set Options
Option #0	Remote Function Actuation / Special Functions / Set Options
Option #1	Personalization / Set Options
Option #1	Remote Function Actuation / Special Functions / Set Options
Option #2	Personalization / Set Options
Option #2	Remote Function Actuation / Special Functions / Set Options
Option #3	Personalization / Set Options
Option #3	Remote Function Actuation / Special Functions / Set Options
Option A	Instrument Panel Cluster / Special Functions / Set Options
Option B	Instrument Panel Cluster / Special Functions / Set Options
Option C	Instrument Panel Cluster / Special Functions / Set Options
Option D	Instrument Panel Cluster / Special Functions / Set Options
Option E	Instrument Panel Cluster / Special Functions / Set Options
Park	Instrument Panel Cluster / Special Functions / PRNDL Display
Park Brake Ratchet Relay	Rear Integration Module / Special Functions / Output Control

Park Brake Release	Heating and Air Conditioning / Special Functions / Output Control / Miscellaneous Test
Park Brake Release Relay	Rear Integration Module / Special Functions / Output Control
Parking Lamps	Body Control Module / Special Functions / Output Control / Light Test
Parking Lamps Relay	Dash Integration Module / Special Functions / Output Control
Passenger Mirror Down	Memory Mirror Module / Special Functions / Output Control
Passenger Mirror Left	Memory Mirror Module / Special Functions / Output Control
Passenger Mirror Right	Memory Mirror Module / Special Functions / Output Control
Passenger Mirror Up	Memory Mirror Module / Special Functions / Output Control
Passlock Power	Body Function Controller / Special Functions / Output Control
PBUS	Remote Function Actuation / Special Functions / Output Control
Perimeter Lighting	Remote Function Actuation / Special Functions / Output Control
Point of Sale	Body Control Module / Special Functions / Set Options
Point of Sale	Dash Integration Module / Special Functions / Set Options
Point of Sale	Onstar / Personalization / Set Options
Position Lamp Relay	Dash Integration Module / Special Functions / Output Control
Power Down Now	Body Control Module / Special Functions / Output Control
Power Moding	Body Control Module / Special Functions / Output Control
Program Both Key Fobs	Remote Function Actuation / Special Functions / Programmable FOBs
Program Engine Type	Immobilizer / Special Functions
Program Immobilizer	Immobilizer / Special Functions
Program Key Cylinder Number	Immobilizer / Special Functions
Program Key Fob 1	Remote Function Actuation / Special Functions / Programmable FOBs
Program Key Fob 2	Remote Function Actuation / Special Functions / Programmable FOBs
Program Key Fobs	Body Control Module / Special Functions
Program Key FOBS	Remote Function Actuation / Special Functions (Refer to Fob #1, Fob #2, etc.)
Program Transponder Keys	Immobilizer / Special Functions
Program VIN	Immobilizer / Special Functions
Programmable FOBs	Remote Function Actuation / Special Functions (Refer to Fob #1, Fob #2, etc.)
Radio Theft	Radio / Special Functions
RAP Relay	Rear Integration Module / Special Functions / Output Control (Refer to Retained Accessory Power)
Rear Blower Power Relay	Rear Integration Module / Special Functions / Output Control

Rear Compartment Lid Release	Body Control Module / Special Functions / Output Control / Miscellaneous Test
Rear Courtesy Light	Rear Integration Module / Special Functions / Output Control
Rear Defog Relay	Rear Integration Module / Special Functions / Output Control
Rear Defogger	Body Control Module / Special Functions / Output Control
Rear Defogger	Heating and Air Conditioning / Special Functions / Output Tests
Rear Door Release Relay	Rear Integration Module / Special Functions / Output Control
Rear Down & Recline Back	Memory Seat Module / Special Functions / Output Control
Rear Down	Seat Control Module / Special Functions / Output Control
Rear Fog Lamp Relay	Rear Integration Module / Special Functions / Output Control
Rear Speakers	Amplifier (Bose) / Special Functions / Output Control
Rear Speakers	Amplifier (Delco) / Special Functions / Output Control
Rear Speakers	Radio / Special Functions / Output Control
Rear Up	Memory Seat Module / Special Functions / Output Control
Rear Up	Seat Control Module / Special Functions / Output Control
Rear Up/Down	Memory Seat Module / Special Functions / Output Control
Recalibrate all Motors	Instrument Panel Module / Special Functions / Miscellaneous Test
Receiver Identification	Entertainment & Comfort Bus
Recirculation Solenoid	Heating and Air Conditioning / Special Functions / Output Control / Solenoid Test
Recline Forward	Memory Seat Module / Special Functions / Output Control
Recline Forward/Backward	Memory Seat Module / Special Functions / Output Control
Region Code Options	Radio / Special Functions / Set Options
Remote Compact Disc Changer	Entertainment & Comfort Bus / E & C Control
Remote Lock Verification Mode	Onstar / Personalization / Set Options
Remote Unlock Verification Mode	Onstar / Personalization / Set Options
Retained Accessory Power	Remote Function Actuation / Special Functions / Output Control
Reverse	Instrument Panel Cluster / Special Functions / PRNDL Display
Reverse Relay	Body Control Module / Special Functions / Output Control / Miscellaneous Test
Reverse Relay	Rear Integration Module / Special Functions / Output Control
Reverse Valve Test	HTCM / Special Functions
Right Air Mix Door Motor Test	Heating and Air Conditioning / Special Functions
Right Front Midrange	Radio / Special Functions / Output Control / Front Speakers
Right Front Tweeter	Radio / Special Functions / Output Control / Front Speakers

Right Rear Subwoofer	Radio / Special Functions / Output Control / Rear Speakers
Right Temp Door Position	Heating and Air Conditioning / Special Functions / HVAC Motors
Right Temp Door Position	Instrument Panel Module / Special Functions / HVAC Motors
2nd	Instrument Panel Cluster / Special Functions / PRNDL Display
Seat Belt Lamp	Instrument Panel Cluster / Special Functions / Lamp Test
Seat Forward	Memory Seat Module / Special Functions / Output Control
Seat Forward	Seat Control Module / Special Functions / Output Control
Seat Forward/Backward	Memory Seat Module / Special Functions / Output Control
Seat Reverse	Seat Control Module / Special Functions / Output Control
Second Head LED Driver	Heating and Air Conditioning / Special Functions / Output Control / Misc. Test
Secure Vehicle	Rear Integration Module / Special Functions / Output Control
Security Lamp	Passlock / Special Functions / Output Tests
Security Lamp	Instrument Panel Cluster / Special Functions / Lamp Test
Security Telltale	Body Control Module / Special Functions / Output Control / Miscellaneous Test
Security Telltale	Remote Function Actuation / Special Functions / Output Control
Segment Check	Driver Information Center / Special Functions
Segment Test	Driver Information Center / Special Functions
Service 4WD Lamp	Instrument Panel Cluster / Special Functions / Lamp Test
Service Now Lamp	Instrument Panel Cluster / Special Functions / Lamp Test
Setup New DIM	Dash Integration Module / Special Functions
Setup New Onstar	Onstar / Special Functions
Setup New VTD (Vehicle Theft Deterrent) Module	Vehicle Theft Deterrent / Special Functions
Solenoid Test	Heating and Air Conditioning / Special Functions / Output Control
Speed and Key Relearn	Body Control Module / Special Functions
Speed Gauge Sweep Test	Instrument Panel Cluster / Special Functions / IPC Gauges
Speedometer Gauge Sweep	Instrument Panel Cluster / Special Functions / Output Control
Starter Enable	Instrument Panel Cluster / Special Functions / Output Control
Sunroof Actuator Control	Power Roof / Special Functions
Synchronize IPC & SIR	Instrument Panel Cluster / Special Functions
Synchronize MSM and TTM	Memory Seat Module / Special Functions
Synchronize TTM and MSM	Tilt Telescope Module / Special Functions / Output Control
3rd	Instrument Panel Cluster / Special Functions / PRNDL Display



Tach Gauge Sweep Test	Instrument Panel Cluster / Special Functions / IPC Gauges
Tachometer Gauge Sweep	Instrument Panel Cluster / Special Functions / Output Control
Telescope In/Out	Tilt Telescope Module / Special Functions / Output Control
Temp Door Mode Valve Test	HTCM / Special Functions
Temperature Lamp	Instrument Panel Cluster / Special Functions / Lamp Test
Theater Dimming #1	Body Control Module / Special Functions / Output Control
Theater Dimming #2	Body Control Module / Special Functions / Output Control
Tilt Up/Down	Tilt Telescope Module / Special Functions / Output Control
Traction Active Lamp	Instrument Panel Cluster / Special Functions / Lamp Test
Traction Off Lamp	Instrument Panel Cluster / Special Functions / Lamp Test
Trunk Release	Body Control Module / Special Functions / Output Control / Miscellaneous Test
Trunk Release	Remote Function Actuation / Special Functions / Output Control
Trunk Release Relay	Rear Integration Module / Special Functions / Output Control
Twilight Telltale	Body Control Module / Special Functions / Output Control / Miscellaneous Test
Upper Motor	Heating and Air Conditioning / Special Functions / Output Control / Miscellaneous Test
Upshift Lamp	Instrument Panel Cluster / Special Functions / Lamp Test
Vacuum solenoid #1	Heating and Air Conditioning / Special Functions / Output Tests
Vacuum solenoid #2	Heating and Air Conditioning / Special Functions / Output Tests
Vacuum solenoid #3	Heating and Air Conditioning / Special Functions / Output Tests
Vacuum solenoid #4	Heating and Air Conditioning / Special Functions / Output Tests
Volts Gauge Sweep Test	Instrument Panel Cluster / Special Functions / IPC Gauges
Volts Lamp	Instrument Panel Cluster / Special Functions / Lamp Test
VTD Options Reset	Instrument Panel Cluster / Special Functions / IPC Options
Wow Instrument Cluster	Body Function Controller / Special Functions / Output Control
WOW the Dash and HUD	Instrument Panel Cluster / Special Functions / Output Control

## CHASSIS PATHING TABLE

### Tech 2 Chassis Diagnostics Pathing Table

ABS Active Lamp Test	ABS/TCS \ Special Functions \ Lamp Test
ABS Indicator Lamp Test	ABS \ Special Functions \ Lamp Test
ABS Lamp Test	ABS/TCS \ Special Functions \ Lamp Test
ABS Lamp Test	VCM 4WAL \ Special Functions
ABS Lamp Test	VCM OBD2 4WAL \ Special Functions
ABS Motor Tests	Special Functions
ABS Warning Lamp	ABS/TCS \ Special Functions \ ABS \ Lamp Tests
ABS Warning Lamp	ABS/TCS \ Special Functions \ TCS \ Lamp Tests
ABS Warning Lamp	ABS/TCS/Magnasteer\ Special Functions \ Lamp Tests
ABS Warning Lamp	Special Functions \ ABS \ Lamp Tests
Automated Bleed	Special Functions
Automated Bleed	4WAL 3 Sensor \ Special Functions
Automated Bleed	ABS \ Special Functions
Automated Bleed	ABS only \ Special Functions
Automated Bleed	ABS/TCS BLW ICCS3 \ Special Functions
Automated Bleed	ABS/TCS/Magnasteer\ Special Functions
Automated Bleed	ABS/TCS/TIM \ Special Functions
Automated Bleed	ABS/TIM \ Special Functions
Automated Bleed	Delco/Bosch ABS \ Special Functions
Automated Bleed	Delco/Bosch ABS/TCS \ Special Functions
Automated Bleed	Delco/Bosch ABS/TCS ICCS1 \ Special Functions
Automated Bleed	Delco/Bosch ABS/TCS ICCS2 \ Special Functions
Automated Bleed	Delco/Bosch ABS/TCS ICCS3 \ Special Functions
Automated Bleed	Teves ABS/TCS \ Special Functions
Automated Test	ABS \ Special Functions
Automated Test	ABS/TCS \ Special Functions
Automated Test	ABS/TCS \ Special Functions \ ABS
Automated Test	ABS/TCS \ Special Functions \ TCS
Automated Test	ABS/TCS/ BLW ICCS3 \ Special Functions
Automated Test	ABS/TCS/Magnasteer\ Special Functions

Automated Test	ABS/TCS/TIM \ Special Functions
Automated Test	ABS/TIM \ Special Functions
Automated Test	Delco/Bosch ABS \ Special Functions
Automated Test	Delco/Bosch ABS/TCS \ Special Functions
Automated Test	Delco/Bosch ABS/TCS ICCS1 \ Special Functions
Automated Test	Delco/Bosch ABS/TCS ICCS2 \ Special Functions
Automated Test	Delco/Bosch ABS/TCS ICCS3 \ Special Functions
Automated Test	Special Functions \ ABS
Automated Test	Teves ABS/TCS \ Special Functions
Bleed Prep	Special Functions \ ABS
Bleed Prep	ABS/TCS \ Special Functions \ ABS
Brake Lamp Test	VCM 4WAL \ Special Functions
Brake Lamp Test	VCM OBD2 4WAL \ Special Functions
Brake Lamp Test	VCM RWAL \ Special Functions
Brake Relay Test	VCM 4WAL \ Special Functions
Brake Switch Test	RWAL \ Special Functions
Clear DTC Information	Select Ride
Controller Information	ABS/TCS/Magnasteer\ ID Information
Damper Actuator Test	CVRSS/ELC \ Special Functions
Damper Actuator Test	CVRTD \ Special Functions
Diagnostics	Delco/Bosch ABS \ Magna Steer
DRA Check	RWAL \ Special Functions
DTC History	Delco/Bosch ABS \ Magna Steer
DTC Information	Delco/Bosch ABS \ Magna Steer
Duty Cycle Test	VES
Electronic Level Control Test	CVRSS/ELC \ Special Functions
EMB Test	Special Functions
EVO PWM	Electronic Variable Orifice \ Special Functions \ Output Control
Flash DTC Information	Select Ride
Function Test	4WAL 3 Sensor \ Special Functions
Function Test	4WAL 4 Sensor \ Special Functions
Function Test	RWAL \ Special Functions
Function Test	VCM 4WAL \ Special Functions
Function Test	VCM OBD2 4WAL \ Special Functions

Function Test	VCM RWAL \ Special Functions
Gear Tension Relief	Special Functions
Gear Tension Relief	Special Functions \ ABS
Gear Tension Relief	ABS only \ Special Functions
Gear Tension Relief	ABS/ETS \ Special Functions
Gear Tension Relief	ABS/TCS \ Special Functions \ ABS
History Data	4WAL 3 Sensor \ Special Functions
History Data	4WAL 4 Sensor \ Special Functions
History Data	VCM 4WAL \ Special Functions
Hydraulic Control	Special Functions
Hydraulic Control	Special Functions \ ABS
Hydraulic Control	ABS only \ Special Functions
Hydraulic Control	ABS/ETS \ Special Functions
Hydraulic Control	ABS/TCS \ Special Functions \ ABS
ICCS2 Data Link Test	ABS/TCS/ BLW ICCS3 \ Special Functions
ICCS2 Data Link Test	CVRSS/ELC \ Special Functions
ICCS2 Data Test	Delco/Bosch ABS/TCS ICCS2 \ Special Functions
Idle Up Test	Special Functions
Idle Up Test	ABS only \ Special Functions
Lamp Test	Special Functions
Lamp Test	Special Functions \ ABS
Lamp Test	Special Functions \ TCS
Lamp Test	ABS only \ Special Functions
Lamp Test	ABS/ETS \ Special Functions
Lamp Test	ABS/TCS \ Special Functions
Lamp Tests	ABS/TCS \ Special Functions \ ABS
Lamp Tests	ABS/TCS \ Special Functions \ TCS
Lamp Tests	ABS/TCS/Magnasteer\ Special Functions
Lamp Tests	Special Functions \ ABS
Lamp/Message(s) Test	ABS \ Special Functions
Lamp/Message(s) Test	ABS/TCS/ BLW ICCS3 \ Special Functions
Lamp/Message(s) Test	ABS/TCS/TIM \ Special Functions
Lamp/Message(s) Test	ABS/TIM \ Special Functions
Lamp/Message(s) Test	Delco/Bosch ABS \ Special Functions

Lamp/Message(s) Test	Delco/Bosch ABS/TCS \ Special Functions
Lamp/Message(s) Test	Delco/Bosch ABS/TCS ICCS1 \ Special Functions
Lamp/Message(s) Test	Delco/Bosch ABS/TCS ICCS2 \ Special Functions
Lamp/Message(s) Test	Delco/Bosch ABS/TCS ICCS3 \ Special Functions
Lamp/Message(s) Test	Teves ABS/TCS \ Special Functions
Left Front	ABS/TCS \ Special Functions \ Pilot Valve Test
Left Front Solenoid	Special Functions
Left Front Solenoid Test	ABS only \ Special Functions \ Solenoid Test
Left Front Solenoid Test	ABS/TCS \ Special Functions \ Solenoid Test
Left Front Solenoid Valve Test	ABS \ Special Functions \ Solenoid Test
Left Rear Solenoid	Special Functions
Left Rear Solenoid Test	ABS/TCS \ Special Functions \ Solenoid Test
LF Inlet Valve Solenoid	ABS/TCS \ Special Functions \ ABS \ Solenoid Tests
LF Inlet Valve Solenoid	ABS/TCS \ Special Functions \ TCS \ Solenoid Tests
LF Inlet Valve Solenoid	ABS/TCS/Magnasteer\ Special Functions \ Solenoid Tests
LF Inlet Valve Solenoid	Special Functions \ ABS \ Solenoid Tests
LF Outlet Valve Solenoid	ABS/TCS \ Special Functions \ ABS \ Solenoid Tests
LF Outlet Valve Solenoid	ABS/TCS \ Special Functions \ TCS \ Solenoid Tests
LF Outlet Valve Solenoid	ABS/TCS/Magnasteer\ Special Functions \ Solenoid Tests
LF Outlet Valve Solenoid	Special Functions \ ABS \ Solenoid Tests
Low Trac Lamp	ABS/TCS \ Special Functions \ ABS \ Lamp Tests
Low Trac Lamp	ABS/TCS \ Special Functions \ TCS \ Lamp Tests
Low Trac Lamp	ABS/TCS/Magnasteer\ Special Functions \ Lamp Tests
Low Trac Lamp	Special Functions \ ABS \ Lamp Tests
LR Inlet Valve Solenoid	ABS/TCS \ Special Functions \ ABS \ Solenoid Tests
LR Inlet Valve Solenoid	ABS/TCS \ Special Functions \ TCS \ Solenoid Tests
LR Inlet Valve Solenoid	ABS/TCS/Magnasteer\ Special Functions \ Solenoid Tests
LR Inlet Valve Solenoid	Special Functions \ ABS \ Solenoid Tests
LR Outlet Valve Solenoid	ABS/TCS \ Special Functions \ ABS \ Solenoid Tests
LR Outlet Valve Solenoid	ABS/TCS \ Special Functions \ TCS \ Solenoid Tests
LR Outlet Valve Solenoid	ABS/TCS/Magnasteer\ Special Functions \ Solenoid Tests
LR Outlet Valve Solenoid	Special Functions \ ABS \ Solenoid Tests
Magna Steer Test	Delco/Bosch ABS \ Magna Steer
Magna Steer Test	Delco/Bosch ABS/TCS \ Magna Steer

Magnasteer Test	ABS/TCS/Magnasteer\ Special Functions
Manual Control	Special Functions \ ABS
Manual Control	ABS only \ Special Functions
Manual Control	ABS/ETS \ Special Functions
Manual Control	Special Functions
Manual Control	Special Functions \ TCS
Manual Control	ABS/TCS \ Special Functions \ ABS
Miscellaneous Test	VES
Motor Control	ABS/TCS \ Special Functions \ ABS
Motor Rehome	Special Functions
Motor Rehome	Special Functions \ ABS
Motor Rehome	ABS only \ Special Functions
Motor Rehome	ABS/ETS \ Special Functions
Motor Rehome	ABS/TCS \ Special Functions \ ABS
Motor Test	Special Functions
Motor Test	Special Functions \ ABS
Motor Test	Special Functions \ TCS
Motor Test	ABS only \ Special Functions
Motor Test	ABS/ETS \ Special Functions
Pilot Valve Test	ABS/TCS \ Special Functions
PROM ID	4WAL 3 Sensor \ Special Functions
PROM ID	4WAL 4 Sensor \ Special Functions
PROM ID	VCM 4WAL \ Special Functions
Pump Motor	Special Functions
Rear Axle Solenoid Test	ABS only \ Special Functions \ Solenoid Test
Rear Solenoid Valve Test	ABS \ Special Functions \ Solenoid Test
Recalibration	CVRSS/ELC
Recalibration	Delco/Bosch ABS/TCS \ Magna Steer
Relay Test	Special Functions
Relay Test	Special Functions \ TCS
Relay Test	Special Functions \ ABS
Relay Test	ABS only \ Special Functions
Relay Test	ABS/ETS \ Special Functions
Relay Test	ABS/TCS \ Special Functions \ ABS

Relay Test	VCM OBD2 4WAL \ Special Functions
Return Pump Relay Test	ABS \ Special Functions
RF Inlet Valve Solenoid	ABS/TCS \ Special Functions \ ABS \ Solenoid Tests
RF Inlet Valve Solenoid	ABS/TCS \ Special Functions \ TCS \ Solenoid Tests
RF Inlet Valve Solenoid	ABS/TCS/Magnasteer\ Special Functions \ Solenoid Tests
RF Inlet Valve Solenoid	Special Functions \ ABS \ Solenoid Tests
RF Outlet Valve Solenoid	ABS/TCS \ Special Functions \ ABS \ Solenoid Tests
RF Outlet Valve Solenoid	ABS/TCS \ Special Functions \ TCS \ Solenoid Tests
RF Outlet Valve Solenoid	ABS/TCS/Magnasteer\ Special Functions \ Solenoid Tests
RF Outlet Valve Solenoid	Special Functions \ ABS \ Solenoid Tests
Right Front	ABS/TCS \ Special Functions \ Pilot Valve Test
Right Front Solenoid	Special Functions
Right Front Solenoid Test	ABS only \ Special Functions \ Solenoid Test
Right Front Solenoid Test	ABS/TCS \ Special Functions \ Solenoid Test
Right Front Solenoid Valve Test	ABS \ Special Functions \ Solenoid Test
Right Rear Solenoid	Special Functions
Right Rear Solenoid Test	ABS/TCS \ Special Functions \ Solenoid Test
RR Inlet Valve Solenoid	ABS/TCS \ Special Functions \ ABS \ Solenoid Tests
RR Inlet Valve Solenoid	ABS/TCS \ Special Functions \ TCS \ Solenoid Tests
RR Inlet Valve Solenoid	ABS/TCS/Magnasteer\ Special Functions \ Solenoid Tests
RR Inlet Valve Solenoid	Special Functions \ ABS \ Solenoid Tests
RR Outlet Valve Solenoid	ABS/TCS \ Special Functions \ ABS \ Solenoid Tests
RR Outlet Valve Solenoid	ABS/TCS \ Special Functions \ TCS \ Solenoid Tests
RR Outlet Valve Solenoid	ABS/TCS/Magnasteer\ Special Functions \ Solenoid Tests
RR Outlet Valve Solenoid	Special Functions \ ABS \ Solenoid Tests
Service ABS Test Lamp Test	ABS/TCS \ Special Functions \ Lamp Test
Solenoid Test	ABS \ Special Functions
Solenoid Test	ABS only \ Special Functions
Solenoid Test	ABS/TCS/ BLW ICCS3 \ Special Functions
Solenoid Test	ABS/TCS/Magnasteer\ Special Functions
Solenoid Test	ABS/TCS/TIM \ Special Functions
Solenoid Test	ABS/TIM \ Special Functions
Solenoid Test	Delco/Bosch ABS \ Special Functions
Solenoid Test	Delco/Bosch ABS/TCS \ Special Functions

Solenoid Test	Delco/Bosch ABS/TCS ICCS1 \ Special Functions
Solenoid Test	Delco/Bosch ABS/TCS ICCS2 / Special Functions
Solenoid Test	Delco/Bosch ABS/TCS ICCS3 / Special Functions
Solenoid Test	Teves ABS/TCS \ Special Functions
Solenoid Tests	ABS/TCS \ Special Functions
Solenoid Tests	ABS/TCS \ Special Functions \ ABS
Solenoid Tests	ABS/TCS \ Special Functions \ TCS
Solenoid Tests	ABS/TCS/Magnasteer\ Special Functions
Solenoid Tests	Special Functions \ ABS
Steering Position Sensor Test	ABS/TCS/ BLW ICCS3 \ Special Functions
Steering Position Sensor Test	ABS/TCS/Magnasteer\ Special Functions
Steering Position Sensor Test	Delco/Bosch ABS/TCS ICCS1 \ Special Functions
Steering Position Sensor Test	Delco/Bosch ABS/TCS ICCS2 \ Special Functions
Steering Position Sensor Test	Delco/Bosch ABS/TCS ICCS3 \ Special Functions
System Identification	Special Functions
System Identification	Special Functions \ TCS
System Identification	Special Functions \ ABS
System Identification	4WAL 3 Sensor \ Special Functions
System Identification	ABS only \ Special Functions
System Identification	ABS/ETS \ Special Functions
System Identification	ABS/TCS \ Special Functions \ ABS
System Identification	VCM OBD2 4WAL \ Special Functions
TCS Active Lamp Test	ABS/TCS \ Special Functions \ Lamp Test
TCS Control Lamp Test	ABS/TCS \ Special Functions \ Lamp Test
TCS Engaged Lamp Test	ABS/TCS \ Special Functions \ Lamp Test
TCS Indicator Lamp Test	ABS \ Special Functions \ Lamp Test
TCS Off Lamp Test	ABS/TCS \ Special Functions \ Lamp Test
TCS Off Lamp Test	ABS/TCS \ Special Functions \ TCS \ Lamp Tests
TCS Off Lamp Test	ABS/TCS/Magnasteer\ Special Functions \ Lamp Tests
TCS Off Lamp Test	Special Functions \ ABS \ Lamp Tests
TCS Switch Information	ABS/TCS/Magnasteer\ Special Functions
TCS System Test	Delco/Bosch ABS/TCS \ Special Functions
TCS System Test	Teves ABS/TCS \ Special Functions
TCS Test	ABS/TCS \ Special Functions



TCS Test	ABS/TCS/ BLW ICCS3 \ Special Functions
TCS Test	ABS/TCS/TIM \ Special Functions
TCS Test	Delco/Bosch ABS/TCS \ Special Functions
TCS Test	Delco/Bosch ABS/TCS ICCS1 \ Special Functions
TCS Test	Delco/Bosch ABS/TCS ICCS2 \ Special Functions
TCS Test	Delco/Bosch ABS/TCS ICCS3 \ Special Functions
TCS Test	Teves ABS/TCS \ Special Functions
TCS Tests	ABS/TCS \ Special Functions \ TCS
TCS Tests	ABS/TCS/Magnasteer\ Special Functions
TCS Tests	Special Functions \ ABS
Tire Size Calibration	4WAL 4 Sensor \ Special Functions
Tire Size Calibration	4WAL 3 Sensor \ Special Functions
VES	Special Functions
VES Actuator Test	Special Functions
VES Actuator Test	ABS only \ Special Functions
VES Actuator Test	ABS/EVO \ Special Functions
Voltage Load	Special Functions
Voltage Load	Special Functions \ ABS
Voltage Load	ABS only \ Special Functions
Voltage Load	ABS/ETS \ Special Functions
Voltage Load	ABS/TCS \ Special Functions \ ABS
VSS Monitor	RWAL \ Special Functions
VSS Monitor	VCM RWAL \ Special Functions

