

WBE 4430



BOSCH

de Originalbetriebsanleitung
Radauswuchtmaschine

es Manual original
Máquina de equilibrado de ruedas

nl Oorspronkelijke gebruiksaanwijzing
wielbalanceermachine

cs Původní návod k používání
Stroj pro vyvažování kol

en Original instructions
Wheel Balancing Machine

it Istruzioni originali
Equilibratrice per ruote

pt Manual original
Máquina de balanceamento de rodas

tr Orijinal işletme talimatı
Tekerlek balans makinesi

fr Notice originale
Banc d'équilibrage de roues

sv Bruksanvisning i original
Hjulbalanseringsmaskin

pl Oryginalna instrukcja eksploatacji
Wyważarka

zh 原始的指南
车轮动平衡机

Contents

1. Symbols used	33	8. Program structure	44
1.1 In the documentation	33	8.1 Balancing	44
1.1.1 Warning notices - Structure and meaning	33	8.2 Rim data	44
1.1.2 Symbols in this documentation	33	8.3 Settings and service	45
1.2 On the product	33	8.3.1 Calibration	45
		8.3.2 Settings	45
		8.3.3 User-defined settings	45
		8.3.4 Settings resolutions and units	46
2. User information	34		
2.1 Important notes	34	9. Wheel balancing	46
2.2 Safety instructions	34	9.1 Selection of vehicle type and balancing program	47
2.3 Electromagnetic compatibility (EMC)	34	9.2 Entering rim data	47
		9.3 Measuring unbalance	49
3. Product description	34	9.4 Attaching balance weights	49
3.1 Intended use	34	9.4.1 Splitting balance weights	49
3.2 Prerequisites	34	9.4.2 Without Easyfix®	49
3.3 Scope of delivery	34	9.5.3 With laser beam	50
3.4 Special accessories	34	9.5.4 With Easyfix®	50
3.5 WBE 4430	35	9.5 Manual vernier caliper	50
		9.5.1 Determining rim width	50
4. Commissioning	36	9.5.2 Attaching balance weights	51
4.1 Unpacking	36	9.6 Measuring compasses	51
4.2 Set-up	36		
4.3 Fitting wheel guard	37	10. Unbalance minimization	52
4.4 Fitting monitor	37		
4.5 Fitting gauge arm	38	11. Faults	53
4.6 Fitting tray	38		
4.7 Electrical connection	38	12. Maintenance	55
4.8 Checking the direction of rotation	39	12.1 Cleaning and servicing	55
4.9 Calibration of WBE 4430	39	12.2 Calibration	55
		12.2.1 Call-up of calibration menu	55
5. Fitting and removing the flange	40	12.2.2 Flange calibration	55
5.1 Removing flange	40	12.2.3 Calibration of electronic vernier caliper/gauge arm	56
5.2 Fitting flange	40	12.2.4 Calibration of WBE 4430	57
		12.2.5 Reference measurement	57
6. Fitting and removing the wheel	41		
6.1 Securing the wheel	41	13. Decommissioning	58
6.2 Removing the wheel	41	13.1 Temporary shutdown	58
		13.2 Change of location	58
7. Operation	42	13.3 Disposal and scrapping	58
7.1 Start page	42	13.3.1 Substances hazardous to water	58
7.2 Monitor display	42	13.3.2 WBE 4430 and accessories	58
7.2.1 Status bar	42		
7.2.2 Display field	42	14. Technical data	58
7.2.3 Soft key bar	42	14.1 WBE 4430	58
7.2.4 EXIT key	42	14.2 Operating range	58
7.3 Control panel	42	14.3 Dimensions and weights	59
7.4 Assignment of quick call-up keys	43		

1. Symbols used

1.1 In the documentation

1.1.1 Warning notices - Structure and meaning

Warning notices indicate hazards and their consequences for the user or surrounding persons. Warning notices also describe the measures for preventing these hazards.

The signal word has a crucial importance. It indicates the probability of occurrence and the severity of the hazard in case of non-compliance:

Signal word	Probability of occurrence	Severity of danger if instructions not observed
DANGER	Immediate impending danger	Death or severe injury
WARNING	Possible impending danger	Death or severe injury
CAUTION	Possible dangerous situation	Minor injury

Below you will see an example of the “Live parts” warning notice by way of example, with the signal word **DANGER**:



DANGER – Exposure of live parts on opening the WBE 4430!

Risk of (fatal) injury or heart failure from electric shocks on contact with live components (e.g. master switch, printed circuit boards).

- Work on electrical installations or equipment is only to be performed by qualified electricians or trained personnel under the guidance and supervision of an electrician.
- Disconnect WBE 4430 from the mains before opening.

1.1.2 Symbols in this documentation

Symbol	Designation	Explanation
!	Attention	Warns about possible property damage.
i	Information	Practical hints and other useful information.
1. 2.	Multi-step operation	Instruction consisting of several steps
➤	One-step operation	Instruction consisting of one step.
⇒	Intermediate result	An instruction produces a visible intermediate result.
→	Final result	There is a visible final result on completion of the instruction.

1.2 On the product

! Observe all warning notices on products and ensure they remain legible!



DANGER – Exposure of live parts on opening the WBE 4430!

Risk of (fatal) injury or heart failure from electric shocks on contact with live components (e.g. master switch, printed circuit boards).

- Work on electrical installations or equipment is only to be performed by qualified electricians or trained personnel under the guidance and supervision of an electrician.
- Disconnect the WBE 4430 from the mains before opening.



Disposal

Dispose of used electrical and electronic devices, including cables, accessories and batteries, separately from household waste.



Direction of wheel rotation

Wheel must turn in direction indicated. (see chapter 4.8)



Caution: Laser beams

Risk of serious eye injury from looking into laser beam (for more than 0.2 seconds). Do not look directly into laser source.

2. User information

2.1 Important notes

Important information on copyright, liability and warranty provisions, as well as on equipment users and company obligations, can be found in the separate manual "Important notes on and safety instructions for Bosch Tire Equipment". These instructions must be carefully studied prior to start-up, connection and operation of the WBE 4430 and must always be heeded.

2.2 Safety instructions

All the pertinent safety instructions can be found in the separate manual "Important notes on and safety instructions for Bosch Tire Equipment". These instructions must be carefully studied prior to start-up, connection and operation of the WBE 4430 and must always be heeded.

2.3 Electromagnetic compatibility (EMC)

The WBE 4430 satisfies the requirements of the EMC directive 2004/108/EG.

 The WBE 4430 is a class/category A product as defined by EN 61 326. The WBE 4430 may cause high-frequency household interference (radio interference) so that interference suppression may be necessary. In such cases the user may be required to take the appropriate action.

3. Product description

3.1 Intended use

The WBE 4430 is a wheel balancing machine with mechanical attachment for the balancing of passenger vehicle and motorcycle wheels with a rim diameter of 12"- 30" and a rim width of 1"- 21". The WBE 4430 is to be used exclusively for this purpose and solely for the range of applications specified in these instructions. Any other purpose is not consistent with the intended use and is therefore not permissible.

 The manufacturer cannot accept any liability for possible damage arising from improper use.

3.2 Prerequisites

The WBE 4430 must be installed on a flat surface made of concrete or similar material and anchored in position.

 An uneven or vibrating surface can lead to inaccurate unbalance measurements.

3.3 Scope of delivery

Designation	Order number	No
WBE 4430	Refer to rating plate	
TSEI UNI 5933 M8x20 BRT	1 695 020 709	1
Male eyebolt M10 ZNT	1 695 040 641	1
TCEI UNI 5931 M5x80 TF ZNT B.	1 695 042 207	1
¼ male quick coupler	1 695 042 398	1
Spring pin UNI 6873 8x20	1 695 042 987	1
Width gauge	1 695 602 700	1
Clamp for counter-weights	1 695 606 500	1
Weight position sensor	1 695 629 400	1
Operator manual	1 695 656 428	1
Conical quick-release coupling	1 695 602 400	1
Power supply cable	1 695 652 991	1
Simple feeler front part	1 695 653 510	1
Simple feeler rear part	1 695 653 511	1
M10 ZNT Eye-bolt connection extension	1 695 655 338	1
ZNT calibration pin	1 695 655 496	1
60 g ZN counter weight	1 695 654 377	1
Spec. UNI 6593 8,5X24X4 ZNT flat washer	1 695 040 503	3
TE UNI 5739 MA8X70 8.8 PG TF BRT	1 695 041 315	3
SLM 8 Fischer plug	1 695 041 316	3
Ground fixing bracket	1 695 655 572	2
Safety instruction manual	1 695 104 907	1

3.4 Special accessories

Designation	Order number
Fourth centering cone dia. 120 to 174 mm	1 695 606 300
Cone ø 89-132 internal 40 mm	1 695 653 449
3/4/5 hole quick flange connection kit	1 695 612 100
Three-arm flange for light commercial vehicles	1 695 653 420
TSP flange for BMW	1 695 653 827
M101.25 mm quick fit nut	1 695 654 042
Flange Unit 3/4/5 holes standard nuts	1 695 654 043
Certified 60 g Zn counter-weight	1 695 654 376
4 cones 42-111.5mm kit	1 695 655 293
Quick-fit flange	1 695 654 039
USB printer kit for balancer	1 659 654 956
italian black PS2 keyboard	1 695 800 125
Centering ring ø50/60/66/71 mm	1 695 656 571
10 mm shaft + ring + spacers	1 695 653 430
Case for printer, cones and flanges	1 695 656 409
Keypad support steel sheet	1 695 656 455
Spacer ring for rims	1 695 606 200

3.5 WBE 4430

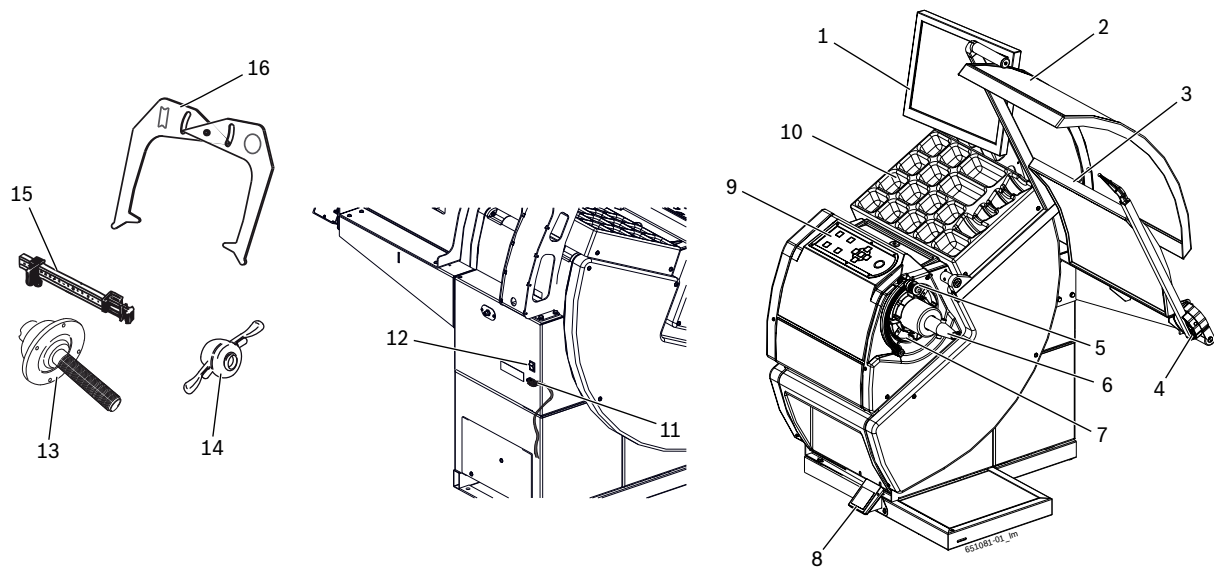



Fig. 1: WBE 4430

Item	Designation	Function/purpose
1	TFT monitor	Software display (measured values and operating instructions)
2	Wheel guard, moving	<ul style="list-style-type: none"> Protection of operator against flying particles (e. g. dirt, water). Starting and stopping measurement, refer to Section 8.3.3
3	Wheel guard, fixed	Protection against flying particles (e. g. dirt, water).
4	Gauge arm	Determination of rim width
5	Vernier caliper (electronic)	<ul style="list-style-type: none"> Recording of rim distance and rim diameter. Determination of positions for attachment of adhesive weights.
6	Cone of drive shaft	Flange mounting
7	Laser	If the Easyfix function is deactivated, the position of the adhesive weights is indicated by a laser beam as soon as the correct balancing position is reached (refer to Section 8.3.2 and 9.3.3).
	Light	Always switched on whenever the electronic vernier caliper is in use.
8	Pedal	Locking of shaft / wheel.
9	Control panel	Operation of WBE 4430, refer to Section 7.3
10	Tray	<ul style="list-style-type: none"> Storage of cones and tools. Storage of balance weights
11	Mains socket	Connection for power cord.
12	On/off switch	Switching WBE 4430 on and off.
13	Centering flange	Wheel attachment.
14	Quick-action clamping nut	Centering and attachment of wheel on cone
15	Manual vernier caliper	Can be used as substitute if the electronic vernier caliper is defective.
16	Measuring compasses	Can be used as substitute if the rim width and rim diameter cannot be recorded electronically.

4. Commissioning

4.1 Unpacking

1. Remove the steel bands and fasteners.
2. Carefully lift off the packaging.
3. Remove the wheel guard, accessories and packaging material from the packaging unit.

 Check that the WBE 4430 and the accessories are in proper working order and that there are no visible signs of component damage. In case of doubt, do not start up the unit and consult customer service.

 Remove the accessories and packaging material from the packaging unit.

4.2 Set-up

1. Slacken off the four bolts with which the WBE 4430 is attached to the pallet.



WARNING – Defective or incorrectly attached lifting straps!

Risk of injury due to WBE 4430 falling down.

- Check lifting straps for physical damage before attaching.
- Tighten lifting straps uniformly.
- Lift WBE 4430 carefully.

2. Attach suitable straps of equal length and adequate loadbearing capacity as shown.

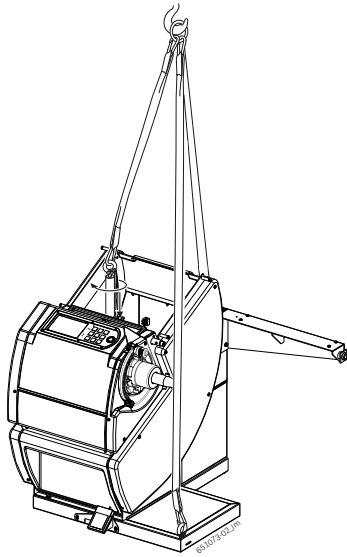

3. Use a crane to lift the WBE 4430. Set up the unit in the intended area, paying attention to the specified minimum distances.

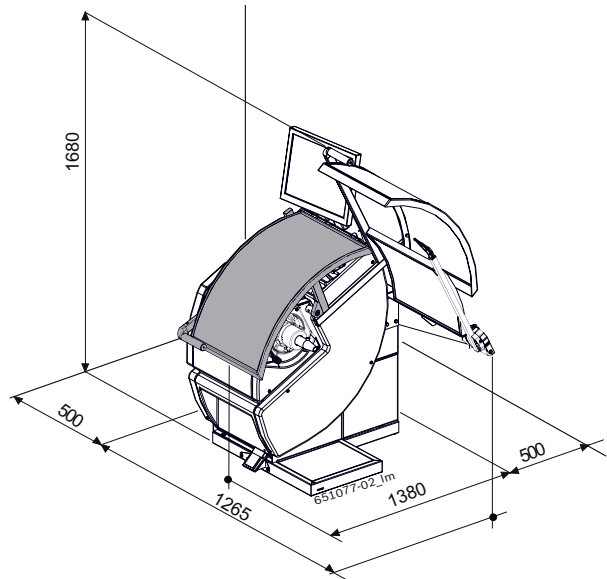

 To ensure a safe and ergonomic use of WBE 4430, the machine must be installed at a distance of about 0.5 m from the nearest wall.



Warning – Risk of tipping

Considerable forces are involved in the wheel balancing process.

- The WBE 4430 must be fixed to the floor in 3 points using a screw and plug and then regulated with the 4th adjusting screw.
- Use bolt holes.

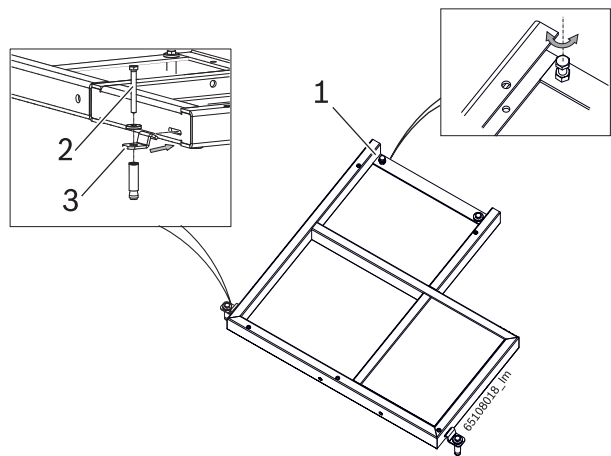
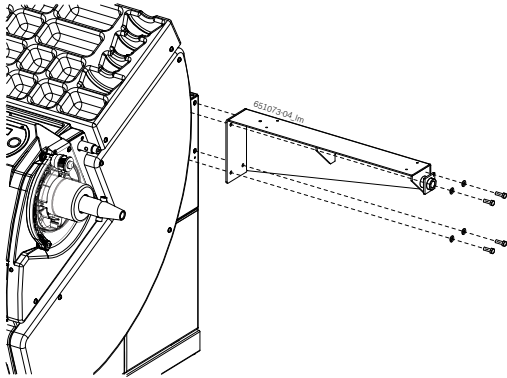

Fig. 2: Fixation of WBE 4430

- 1 Adjusting screw
- 2 Fastening screws
- 3 Bracket

4.3 Fitting wheel guard

1. Use the five bolts supplied to attach the wheel guard support to the WBE 4430 .



2. Use the four bolts supplied to fit the bottom part of the wheel guard to the support.

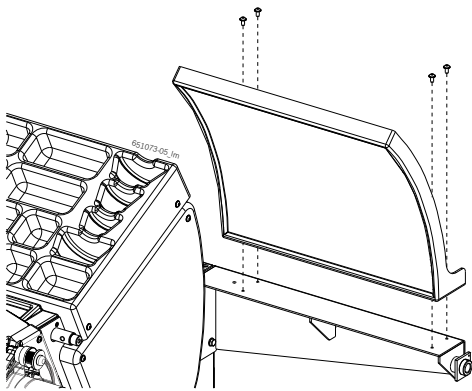

3. Use a pin and bolt to attach the top part of the wheel guard to the WBE 4430 by way of the support arm as shown.

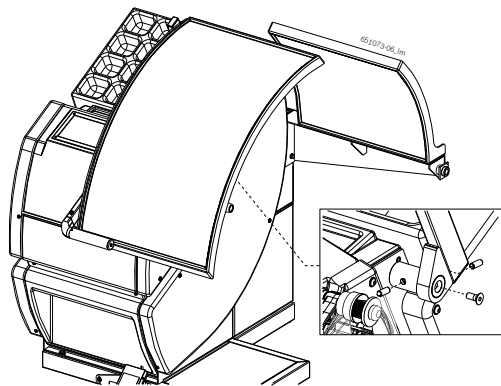

4.4 Fitting monitor

1. Use 4 bolts to attach the monitor arm to the WBE 4430.
2. Use 4 bolts to attach the adapter plate to the monitor.
3. Attach the monitor to the monitor arm.

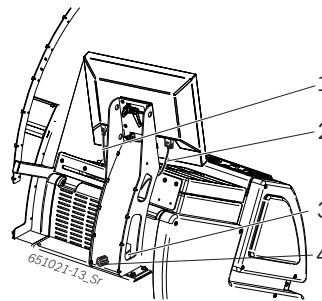



Fig. 3: Fitting monitor

- 1 Monitor power cord
- 2 Monitor VGA connecting cable
- 3 USB connecting cable
- 4 Cap for USB connection

4.5 Fitting gauge arm

 This must be done when the wheel protection cover is already mounted on the machine.

1. Attach the clamp of the angular width gauge on the supporting tube of the wheel protection cover by fastening the three screws in the respective holes.

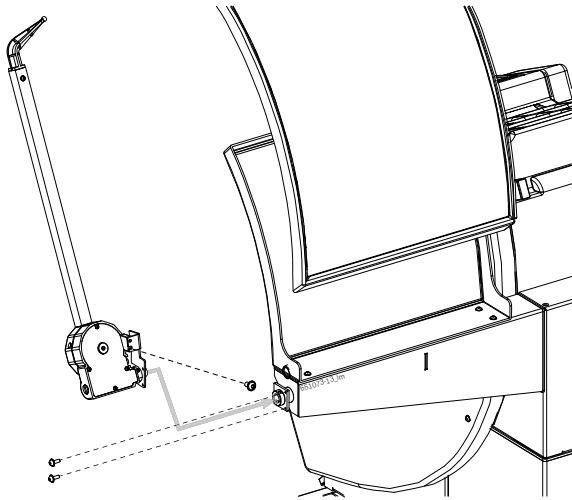

Fig. 4: Assembly of angular width gauge

2. Connect the angular width gauge connection cable onto the rear of the balancing machine and fix it using the straps included, as shown in the picture.

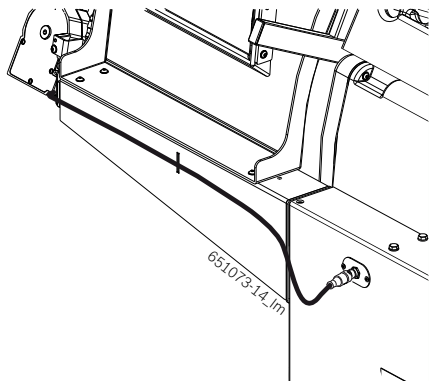
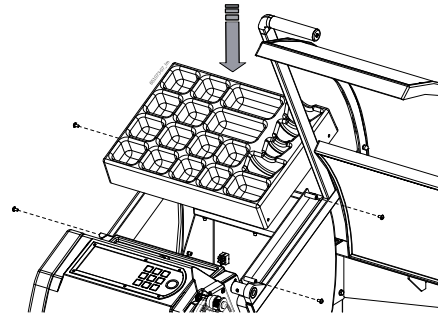

Fig. 5: Connecting the angular width gauge

- 1 The connecting cable of the angular width gauge
- 2 Strap

4.6 Fitting tray

➤ Fit the tray as shown.



4.7 Electrical connection

 The WBE 4430 is only to be connected to the power supply if the mains voltage available corresponds to the rated voltage given on the rating plate.

1. Check whether the mains voltage corresponds to the rated voltage given on the rating plate.
2. Provide fuse protection for the WBE 4430 mains connection in line with locally applicable standards. The customer is responsible for providing fuse protection for the mains connection.
3. Connect the power cord to the WBE 4430.

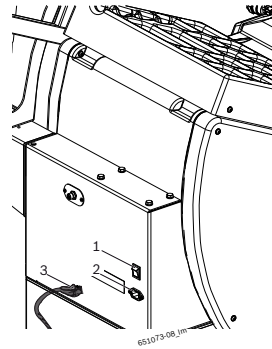



Fig. 6: Electrical connection

- 1 On/off switch
- 2 Mains connection
- 3 Power cord

4.8 Checking the direction of rotation

1. Check that the WBE 4430 is correctly connected to the mains power supply.
2. Switch on the WBE 4430 with the On/Off switch.
3. Close the wheel guard or press the <START> button).
⇒ The shaft rotates.
4. Check the direction of rotation of the shaft.

 The correct direction of rotation is indicated by a yellow arrow on the WBE 4430. This arrow is situated to the right of the flange.

 If the direction of rotation is incorrect, the WBE 4430 comes to an immediate stop and displays the error message **Error 3**(see section 11).

4.9 Calibration of WBE 4430

 Calibration must be performed after initial commissioning.

1. Flange calibration.
2. Vernier caliper and gauge arm calibration.
3. WBE 4430 calibration.
4. Perform reference measurement.

 Calibration is described in Section 12.2

5. Fitting and removing the flange

Fitting of the flange is necessary in the following situations:

- Commissioning
- When changing the type of flange (universal - 3/4/5 hole)
- When changing the type of wheel (passenger car - motorcycle)

! Balancing accuracy will be impaired if the flange has not been properly fitted to the shaft. Before fitting the flange, clean and degrease (remove corrosion protection) the cone of the shaft and the flange opening.

5.1 Removing flange

I The WBE 4430 must be switched on.

1. Press the pedal.
⇒ This blocks the shaft.
2. Slacken off the hexagon socket head bolt.

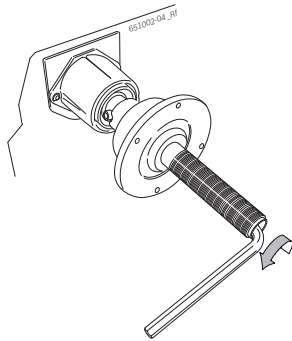

3. Unfasten the flange by tapping with a rubber-headed hammer on the cone end.
4. Pull the flange off the cone.

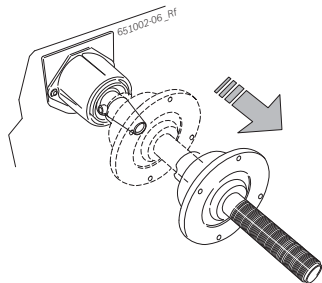

→ Flange detached.

5.2 Fitting flange

I Clean and degrease the cone of the shaft and the flange opening.

1. Press the pedal.
⇒ This blocks the shaft.
2. Slide the flange onto the shaft.

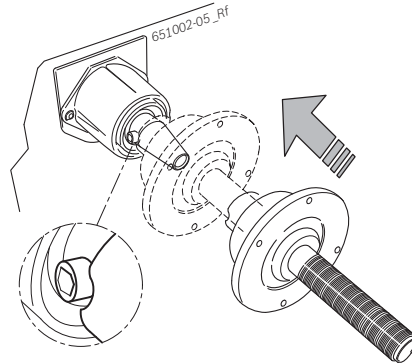

3. Tighten the hexagon socket head bolt.

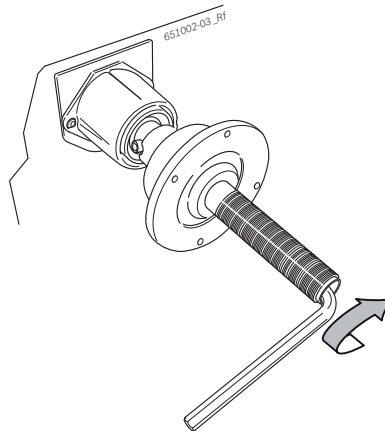

→ Flange fitted.

6. Fitting and removing the wheel



WARNING – Wheel slip!

Risk of crushing of fingers and other body parts when attaching and removing wheel.

- Wear protective gloves.
- Wear safety shoes.
- Do not place fingers between the wheel and the shaft.
- Heavy wheels should always be handled by two people.

6.1 Securing the wheel

1. Switch on the WBE 4430 with the On/Off switch.
2. Position a suitable cone on the shaft (flange).

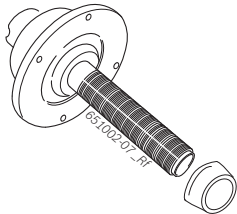

3. Use a wire brush to remove any dirt.
4. Place the wheel on the shaft against the cone.
5. Push the unlocked quick-action clamping nut onto the shaft and press firmly against the wheel.

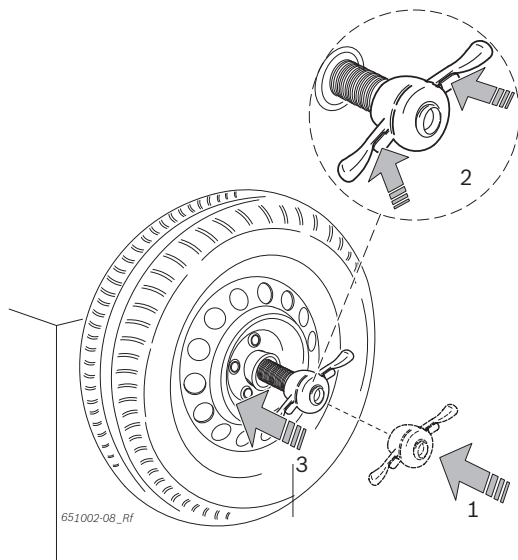

6. Release the lock and turn the quick-action clamping nut clockwise until the wheel is firmly braced.

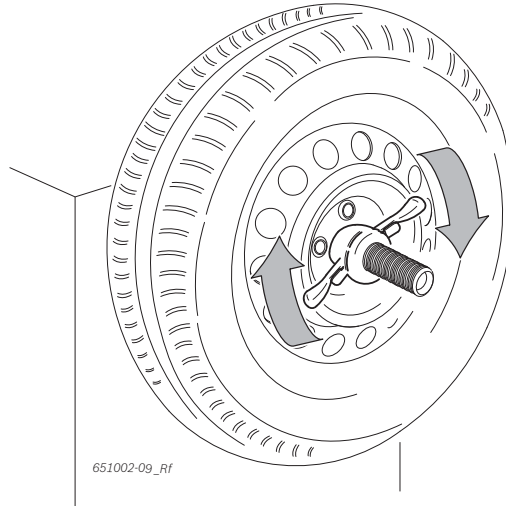

→ The wheel is secure.

6.2 Removing the wheel

1. Turn the quick-action clamping nut anti-clockwise and release the wheel.
2. Unlock and take off the quick-action clamping nut.
3. Remove the wheel.



7. Operation

7.1 Start page

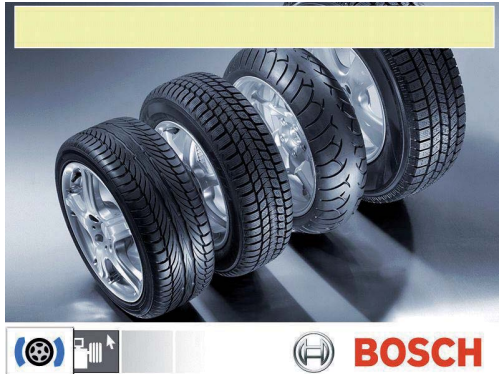
 The initialization of the software is displayed approx. 20 seconds after switching on the WBE 4430. The start page is displayed after a further 40 seconds.



The following menus can be selected on the start page:

Symbol	Designation	Access to menu
	Wheel Balancing	Balancing program
	Settings and service	Personal settings, calibration and customer service.

7.2 Monitor display

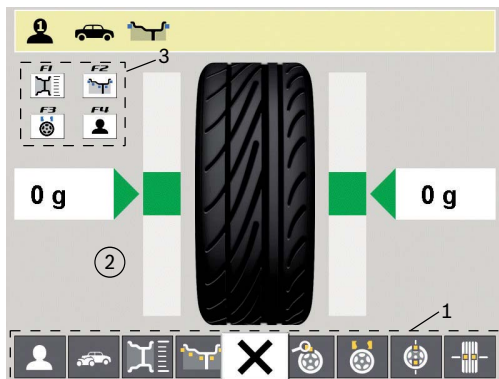

Fig. 7: Balancing main page

- 1 Status bar
- 2 Display field
- 3 Soft key bar

7.2.1 Status bar

The following information is displayed depending on the menu selected:

- Current user.
- Vehicle selected.
- Balancing program selected.
- Number of wheel spokes selected in "**Split program**".

7.2.2 Display field

The following information is displayed here:

- Rim data and positioning of vernier caliper/gauge arm.
- Information on positioning and mass of the balance weights.

7.2.3 Soft key bar

The soft key bar indicates the functions available in the corresponding menu. The functions are started by pressing the function keys.

7.2.4 EXIT key

Symbol	Description
	Press <OK> to return to the previous page.

Pressing this key terminates the menu selected and returns to the previous page.

 Values are only confirmed with <OK>.

7.3 Control panel

The WBE 4430 is operated by way of the quick call-up keys and the arrow keys. The corresponding functions are described in Table 1.

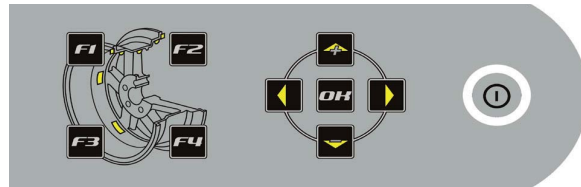

Key	Description
<F1> to <F4>	Quick call-up keys for rapid access to individual menus (refer to Section 7.4 for assignment of the quick keys).
Arrow keys ↑ ↓ ← →	Navigation in the menus and alteration of the rim data values.
<OK>	Confirmation of settings.
<START>	Starts measurement
<STOP>	Ends measurement.









Tab. 1: Functions of quick call-up and control keys

 Touching several arrow keys simultaneously (e.g. with palm of hand) results in exit from the current menu and return to the previous menu.

7.4 Assignment of quick call-up keys

 The quick keys permit direct, rapid call-up of frequently required functions from the control panel.

The following functions can be assigned to a quick call-up key:

	Activate or deactivate the laser beam
	Balancing menu
	"Unbalance minimization" menu
	Vehicle selection
	User selection
	"Split program" menu
	Rim program selection
	Rim data input
	Assignment of function selected to quick call-up key F4

1. Call up the "Settings and service" menu from the start page with $\leftarrow \rightarrow$ and $\langle \text{OK} \rangle$.

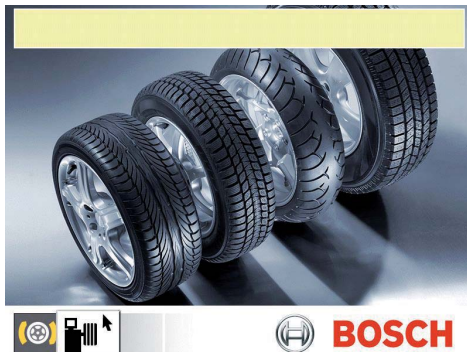

2. Call up the "User-defined settings" menu with $\leftarrow \rightarrow \leftarrow \rightarrow$ and $\langle \text{OK} \rangle$.



3. Select the "Quick call-up key assignment" menu.



4. Use the arrow keys $\rightarrow \leftarrow$ to select the quick call-up key required.
5. Use the arrow keys $\uparrow \downarrow$ to select the required assignment (function) and assign the function to the quick call-up key with $\langle \text{OK} \rangle$.

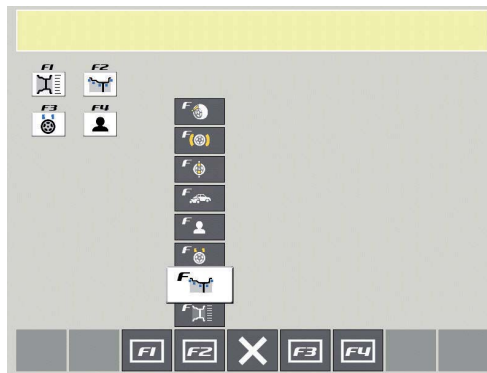

⇒ The quick call-up key is displayed together with the function selected.







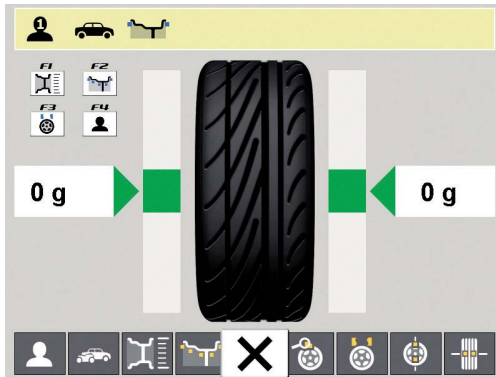
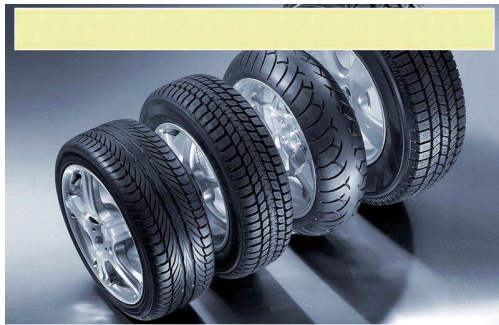

6. Repeat steps 4 and 5 for the other quick call-up keys.

→ The assignment (function) of the quick call-up keys can be altered by the user at any time.

8. Program structure







8.1 Balancing

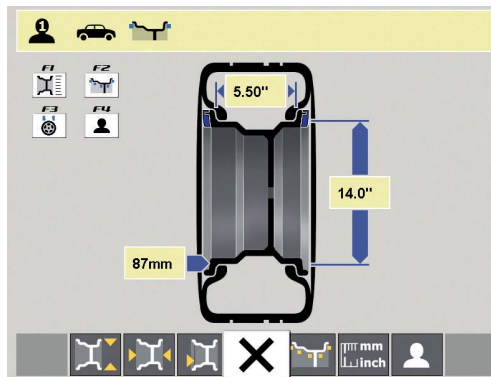
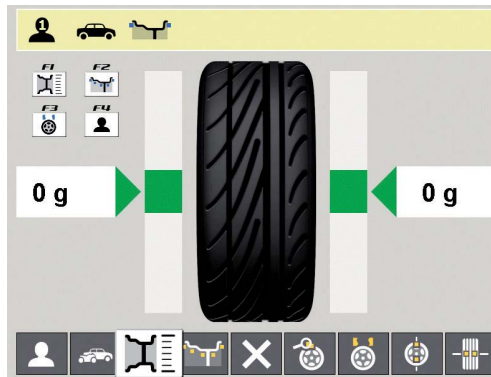

-  Selection of user 1, 2 or 3. The last settings and rim data selected are assigned to the current user and stored.
-  Selection of type of vehicle (passenger car or motorcycle); the type of vehicle selected is displayed in the status bar.
-  Selection of number of spokes. The weight can be distributed behind the spokes after measuring the unbalance.
-  Selection of balancing program; 11 passenger car programs, 5 motorcycle programs; the program selected is displayed in the status bar.
-  Press <OK> to return to the previous page.
-  Display of the exact, non-rounded unbalance measured value.
-  Call-up of the "Enter rim data" menu.
-  Call-up of the "Unbalance minimization" program (refer to Section 10).
-  Brake activation / deactivation to lock the flange and wheel in position.







8.2 Rim data







-  Rim diameter input by way of + / - keys
-  Rim width input by way of + / - keys
-  Input of distance between WBE 4430 and rim by way of + / - keys
-  Press <OK> to return to the previous page.
-  Selection of balancing program; 11 passenger car programs, 5 motorcycle programs; the program selected is displayed in the status bar.
-  Switching of units (mm / inch)
-  Selection of user 1, 2 or 3. The last settings and rim data selected are assigned to the current user and stored.

8.3 Settings and service







-  Open diagnostics menu (only for the assistance service)
-  Open the standard calibration and factory calibration menu (only for the assistance service)
-  Press <OK> to return to the previous page.
-  Settings (customer service only)
-  User-defined settings
-  Settings resolutions and units

 The following symbols are used in the selection menus:

-  Automatic transfer (e.g. time)
-  Manual transfer (e.g. via pedal)
-  Function deactivated





8.3.1 Calibration



-  Calibration with "Go" wheel. (Refer to Section 12.2.4).
-  Flange calibration. (Refer to Section 12.2.2).
-  Press <OK> to return to the previous page.
-  Vernier caliper and gauge arm calibration. (Refer to Section 12.2.3).

8.3.2 Settings









-  Activates or deactivates the brake to lock the flange and wheel in position.
-  Activates or deactivates the vernier caliper and the gauge arm.
-  Press <OK> to return to the previous page.
-  Selection of position transfer by way of time or pedal. Setting not possible, always select time
- 
 - Positioning of **adhesive weight** for ALU2, ALU3 and PAX2:
 - Setting PG: Attachment with Easyfix® : The laser beam ¹⁾ is deactivated and does not provide assistance for attachment of the weight.
 - Setting P3, P6 or P12: With manual vernier caliper or without tools: Attachment in 12, 3 or 6 o'clock position, the laser beam ¹⁾ is activated on reaching the position (rotation of wheel) and provides assistance for attachment of the weight.
 - With all other programs and for all adhesive weights the balance weight must be attached in the 12 o'clock position.

** Depending on version, special accessory in some cases*

8.3.3 User-defined settings



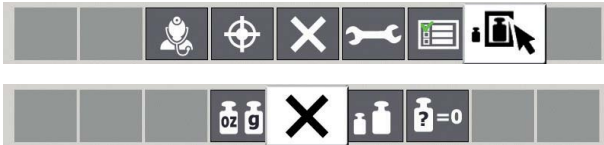

-  Activates or deactivates the screen saver
-  Activates or deactivates acoustic acknowledgement signal
-  Language selection.
-  Activates or deactivates automatic start (start of measurement by closing wheel guard)
-  Press <OK> to return to the previous page.
-  Call-up of "Quick key assignment" (refer to Section 7.4).

8.3.4 Settings resolutions and units



The screenshot shows a settings menu with two rows of icons. The first row contains icons for a scale, a target, a cross, a wrench, a list, and a cursor. The second row contains icons for weight units (oz/g), a cross, a scale, and a scale with a question mark and '0'.

	Selection of weight display grams (g) or ounces (oz).
	Selection of weight resolution 1 g / 0.05 oz or 5 g / 0.25 oz
	Residual value suppression: Entry of weight value below which the value "0" is to be displayed.

9. Wheel balancing

**WARNING – Incorrectly balanced wheels**

Risk of injury due to change in handling characteristics of vehicle.

- WBE 4220 must be positioned on a flat surface and must be firmly bolted to the floor.
- Specified flange must be mounted on clean and grease-free shaft.
- Use the specified accessories (cone, spacer rings).
- Rim must contact flange accurately, remove any dirt.
- Perform a check measurement after applying balancing weights.

1. Switch on the WBE 4430 at the on/off switch.
⇒ The "Start page" is opened.
2. Open the "main page" with <OK>.

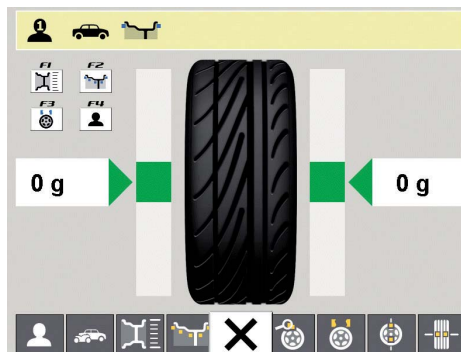











9.1 Selection of vehicle type and balancing program

 Static balancing is recommended for wheels with a width of less than 3.5": In this case only the rim diameter value is entered. The values for distance and width of the rim can be set arbitrarily in inches or mm.

1. Check the currently selected **type of vehicle** (passenger car or motorcycle) in the status bar, alter if necessary and confirm with <OK>.
2. Check the currently selected **balancing program** in the status bar, alter if necessary and confirm with <OK>.

 The current settings for attachment of the adhesive weight (refer to Section 8.3.2) only apply to PAX2 and ALU2 (inside and outside) and ALU3 (inside). Otherwise, the adhesive and clip-on weights are always to be attached in the 12 o'clock position.

	Static balancing on plane 3
	Static balancing on plane 2
	Static balancing on plane 1
	Pax2: Pax rim for concealed adhesive weights ¹⁾
	Pax1: Pax rim with adhesive weights
	Alu5: Adhesive weights on inside / clip-on weights on outside
	Alu4: Clip-on weights on inside / adhesive weights on outside ²⁾
	Alu3: Clip-on weights on inside ¹⁾ / concealed adhesive weights on outside
	Alu2: Concealed adhesive weights ¹⁾
	Alu1: Standard program for adhesive weights ²⁾
	Standard program for clip-on weights

¹⁾ Pay attention to the current settings for attachment of the adhesive weight (refer to Section 8.3.2)!

²⁾ The weight must be raised slightly if the adhesive weight cannot be attached in the vicinity of the outer edge of the rim (rim flange) on account of the design of the rim.

9.2 Entering rim data

 If electronic wheel data recording is not possible, the wheel data can also be entered manually.

 The balancing program can be selected on the page shown in the picture or automatically with the Standard, Alu2, Alu3 programs with simple extraction of the electronic slide gauge. Further selection of these is done automatically according to the number of points detected.

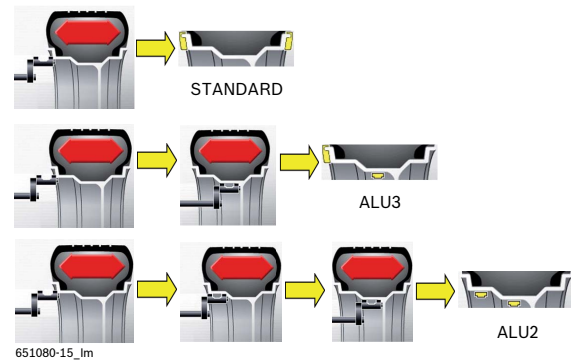

1. Apply the electronic vernier caliper for rim distance and rim diameter to the rim.

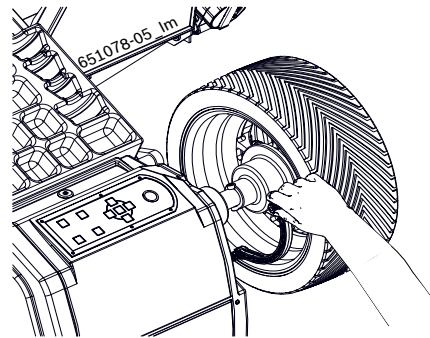

 The measurement location is indicated on the monitor in accordance with the balancing program selected.

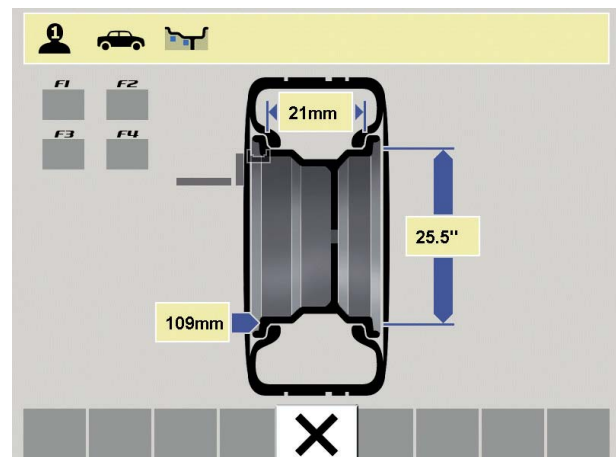

- Storage of the position is confirmed by an acoustic signal and the position data are displayed.

 If you require the Standard program, simply move the slide gauge to its position at rest for carrying out measurement; to run one of the other programs, proceed with acquisition of the subsequent points.

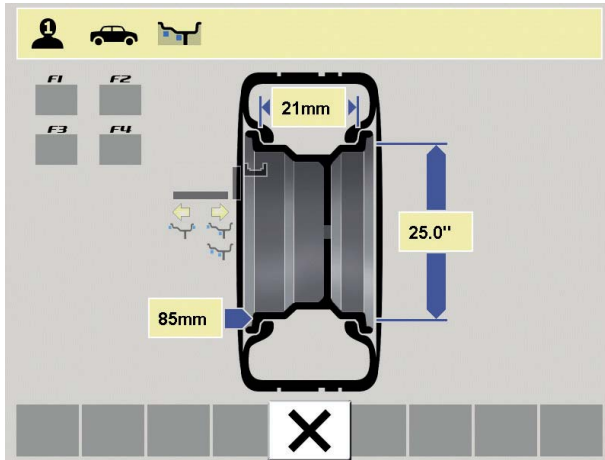

- Apply the electronic vernier caliper for rim distance and rim diameter to the rim.
- Storage of the position is confirmed by an acoustic signal and the position data are displayed.

 If you require the Alu3 program, simply move the slide gauge to its position at rest for carrying out measurement, or proceed with acquisition of the last point for selecting the Alu2 program automatically.

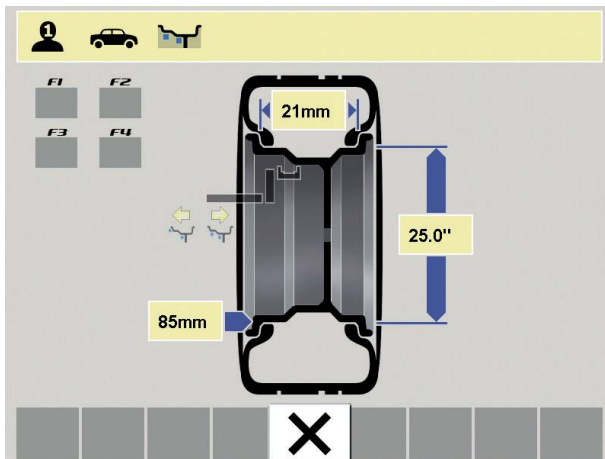

- Apply the electronic vernier caliper for rim distance and rim diameter to the rim.
- Storage of the position is confirmed by an acoustic signal and the position data are displayed.

- The procedure for entering data for internal points is completed; move the slide gauge back to its position at rest.

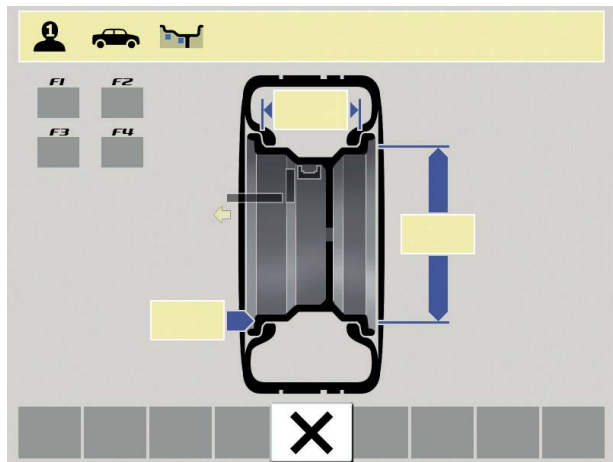

 The electronic gauge arm is not required for the balancing programs Alu2, Alu3 (Easyfix®). Both measurement locations are recorded with the vernier caliper.

 The Alu1, Alu4, Alu5, Pax1 and Standard programs are completed, instead, with the acquisition of the measurement of an external point with the electronic measuring arm, following the procedure described below.

- Apply the electronic gauge arm for rim width to the rim.

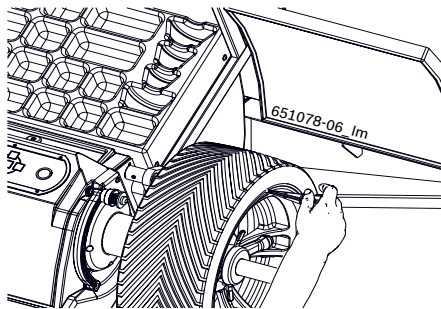

- ⇒ The measurement location is indicated on the monitor in accordance with the balancing program selected.
- ⇒ Storage of the position is confirmed by an acoustic signal and the position data are displayed.

➔ The individual values have now been read in and are displayed on the monitor.

9.3 Measuring unbalance

 A wheel can only be correctly balanced if all the settings correspond to the mounted wheel.

 Measurement can be stopped at any time:

- Press the <STOP> key.
- Press the right pedal.
- Open the wheel guard.

1. Close the wheel guard.

⇒ The unbalance measurement commences automatically.

⇒ On completion of measurement the values of the balance weights required are shown on the display.

On left of display inner balancing plane,
on right of display outer balancing plane.

2. Open the wheel guard.

9.4 Attaching balance weights

 If the unbalance measured at the wheel is extremely high (e. g. static unbalance >50 g) it is advisable to perform "**Unbalance minimization**" (refer to Section 10).

9.4.1 Splitting balance weights

 The "**split program**" is called up after measurement if the balance weights have to be attached at a certain position (e.g. behind the spoke or spokes). We recommend attachment using Easyfix®.

1. Select the split program and the number of spokes.

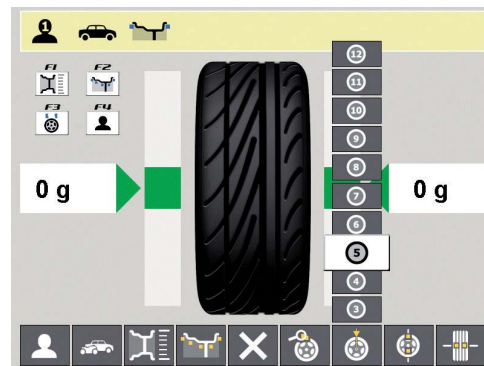

2. Move the required position (e.g. a spoke) to the 12 o'clock position.

3. Confirm with <OK>.

→ The split weights and positions are indicated.

9.4.2 Without Easyfix®

1. Turn the wheel by hand.

⇒ As soon as the correct position for attachment of a balance weight has been reached, a green square appears on the monitor.

 Blue squares on either side of the tyre on the monitor indicate the direction in which the wheel has to be turned to move it to the correct position for the next balance weight.

2. Select a balance weight of the required value (next to the green square).

3. Attach the balance weight at the highest vertical position (12 o'clock) of the wheel.

 The position depends on the setting selected for the attachment location (refer to Section 8.3.2)

4. Repeat the procedure for the 2nd balance weight.

 After attaching the balance weights, the unbalance must be measured again for an exact check of the balance.

9.5.3 With laser beam

 A laser beam provides assistance for manual attachment of the adhesive weights (without Easyfix®).

 The user must make a note of the distance from the edge of the rim when specifying the position of the weight. This dimension must also be observed when attaching the weight.

1. Deactivate Easyfix® in the "Settings" menu (refer to Section 8.3.2).
2. Turn the wheel to the correct position.
 - ⇒ The laser is activated and the laser beam shows a line on the rim.
3. Centrally align the weight with the laser beam and affix it at the distance from the edge of the rim determined previously.

 Clip-on weights are always attached at the 12 o'clock position irrespective of the settings. The 12 o'clock position is indicated by the laser.

9.5.4 With Easyfix®

 Only the 3 programs Alu2, Alu3 and Pax2 support the attachment of the adhesive weights with Easyfix®.

1. Turn the wheel by hand.
 - ⇒ As soon as the correct position for attachment of a balance weight has been reached, the wheel is locked in position and a green square appears on the monitor.

 Blue squares on either side of the tyre on the monitor indicate the direction in which the wheel has to be turned to move it to the correct position for the next balance weight.

2. Select an adhesive weight of the required value (next to the green square).
3. Insert the adhesive weight in the vernier caliper.
4. Move the vernier caliper into the rim.
 - ⇒ The attachment location of the adhesive weight is indicated.
 - ⇒ The vernier caliper is locked at this position (the colour of the square changes from yellow to green).
5. Attach the adhesive weights with the aid of the vernier caliper.
6. Repeat the procedure for the 2nd balance weight.

 After attaching the balance weights, the unbalance must be measured again for an exact check of the balance.

9.5 Manual vernier caliper

In the balancing programs Alu2, Alu3 and Pax2 the manual vernier caliper permits determination of the rim width as well as simple positioning and attachment of the adhesive weights.

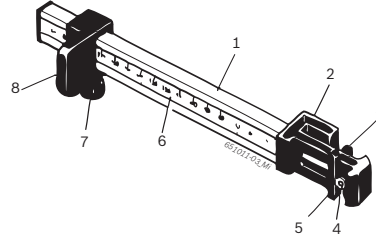
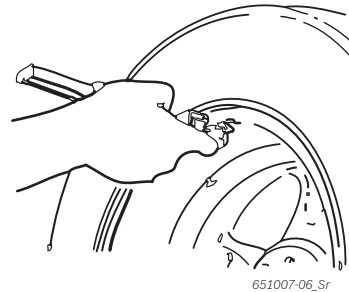

Fig. 8: Manual vernier caliper

- 1 Vernier caliper grip
- 2 Vernier caliper head
- 3 Inner weight pliers
- 4 Ejector
- 5 Outer weight pliers
- 6 Scale
- 7 Knurled screw
- 8 Slider with stop

9.5.1 Determining rim width

1. Position the manual vernier caliper with the slider at the inner rim edge.



2. Move the outer weight pliers to the position at which the balance weights are to be attached.
3. Secure the slider with the knurled screw.
4. Read off the dimension and enter as rim width in "mm".
5. Start measurement "Balancing wheel".
6. Measurement evaluation:
 - ⇒ The value for the adhesive weight to be attached by way of the inner weight pliers (Alu2 and Pax2) or as clip-on weight (Alu3) appears in the left-hand display.
 - ⇒ The value for the adhesive weight to be attached by way of the outer weight pliers appears in the right-hand display.

9.5.2 Attaching balance weights

1. Move the wheel to the corresponding position 12, 3 or 6 o'clock (refer to Section 8.3.2).
2. Insert the adhesive weight required in the outer weight pliers.
3. Position the slider at the edge of the rim.
4. Place the adhesive weight with the ejector at the corresponding position and press on.

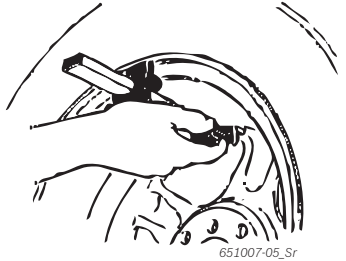

5. Insert the second adhesive weight required in the inner weight pliers.
6. Position the slider at the edge of the rim.
7. Position the adhesive weight with the ejector and press on.

 The clip-on weight is positioned and secured in the balancing program Alu3.

9.6 Measuring compasses

 The rim width can be read off the rim or determined with the measuring compasses.

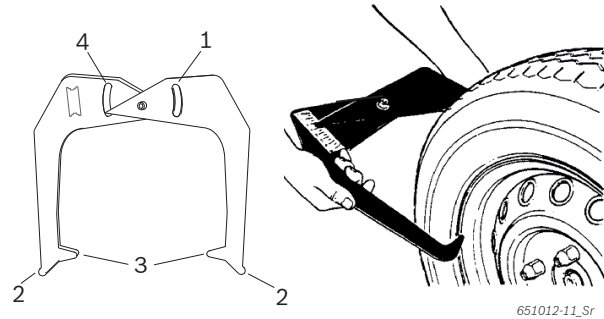

Fig. 9: Determining rim data with measuring compasses

- 1 Rim diameter scale
- 2 Outer tip for rim diameter
- 3 Inner tip for rim width
- 4 Rim width scale

1. Apply the inner tips of the measuring compasses to the rim flange.
2. Read the value off the rim width scale.
3. Enter the rim width determined.

10. Unbalance minimization

If the unbalance measured at the wheel is extremely high (e.g. static unbalance >50 g) it is advisable to perform "**Unbalance minimization**".

The program permits minimization of the total unbalance by providing compensation for the static unbalance of the tyre by way of that of the rim.

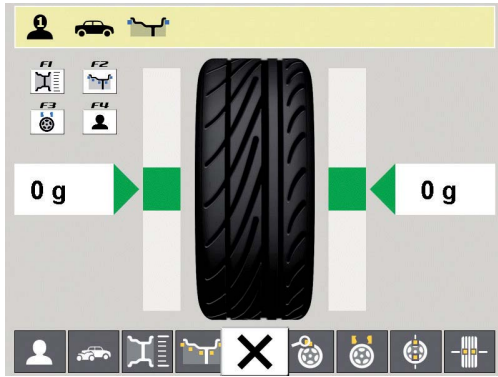

- From the "**Unbalance side**" press → → → and <ok>.
 - ⇒ "**Unbalance minimization**" is opened.

! Work as accurately as possible throughout the entire procedure. Follow the instructions shown on the monitor.

PHASE 1 to PHASE 4:

1. Close the wheel guard.
 - ⇒ Measurement commences.
2. Turn the wheel until the valve is in the 12 o'clock position.
3. Press <OK>.
 - ⇒ The reference position of the wheel on initial starting is stored.
4. Make a reference mark on the tyre (corresponding to the position of the valve).
5. Detach the wheel from the flange.
6. Turn the tyre on the rim through 180 degrees.

ii The mark previously made provides a guide.

7. Clamp the wheel.
8. Turn the valve to the 12 o'clock position.
9. Press <OK>.
 - ⇒ The new position of the wheel on the flange is stored.
10. Close the wheel guard.

→ Measurement commences.

Values obtained:

- Rim unbalance
- Current unbalance
- Tyre unbalance
- Minimum possible unbalance

ii After studying the values, further unbalance minimization is required (PHASE 5 to 7).

PHASE 5 to PHASE 7:

1. Turn the wheel until the arrows on the monitor are centered.
2. Mark the tyre at the 12 o'clock position.
3. Press <OK>.
4. Detach the wheel from the flange.
5. Turn the tyre on the rim until the mark coincides with the position of the valve.
6. Clamp the wheel.
7. Turn the valve to the 12 o'clock position.
8. Press <OK>.
 - ⇒ The new position of the wheel on the flange is stored.

ii To turn the tyre on the rim it may be necessary to deflate the tyre, unseat it again and re-inflate after turning.

9. Close the wheel guard.
 - ⇒ The test run commences.

ii If the test run is to be repeated, the monitor displays an appropriate message. In this case, continue again with minimization (PHASE 5 onwards).

→ On completion of the test run, the unbalance is automatically compared to the minimum residual unbalance value. If the difference between these two values is below the maximum permissible level, the tyre and rim are optimally matched.

10. Press <OK>.
 - ⇒ Return to "**main page**".

ii If the test run is not properly completed, the entire procedure (as of PHASE 1) must be repeated.

11. Press <OK>.

→ Return to "**main page**".

11. Faults

 Other possible malfunctions are primarily of a technical nature and are to be checked and if necessary rectified by a qualified engineer. Always contact the customer service of your authorized Bosch equipment dealer.

 To enable action to be taken quickly, it is important to inform customer service of the specifications on the rating plate (label on the flange end of the WBE 4430) and the nature of the problem.

Faults	Causes	Remedy
The displays do not light on switch-on	<ol style="list-style-type: none"> 1. Defective fuse or missing phase 2. Damaged fuse in electrical connection 3. Damaged fuse in control/display panel 	<ol style="list-style-type: none"> 1. Check the mains connection. 2. Replace the fuse in the electrical connection. 3. Replace the fuse in the control/display panel. Inform customer service. <p>Caution: Repeated fuse damage is an indication of a malfunction.</p>
1	<ol style="list-style-type: none"> 1. Setting and calibration data lost from PCB memory 2. One or more calibration operations (setting, calibration of electronic vernier caliper/gauge arm) not performed 	Check and correct calibration and settings.
2	Wheel guard raised prior to completion of measurement	Wait for end of measurement before raising wheel guard.
3	<ol style="list-style-type: none"> 1. Backward rotation of wheel on start of measurement 2. Incorrect connection of motor 	<ol style="list-style-type: none"> 1. Check that wheel is stationary on starting and stop it turning backwards on starting. 2. Check proper connection of motor.
4	<ol style="list-style-type: none"> 1. No motor operation, motor does not attain the necessary speed 2. Fault in electrical connection 3. Fault in PCB 	<ol style="list-style-type: none"> 1. Check mains voltage (probably too low). 2. Check electrical connection or power cord. 3. Replace the PCB.
5	<ol style="list-style-type: none"> 1. Balance weight not attached to wheel 2. Measurement sensors not correctly connected 	<ol style="list-style-type: none"> 1. Repeat calibration from the start and attach balance weight as specified by the process. (refer to 12.2). 2. Check the connection of the measurement sensors.
6	<ol style="list-style-type: none"> 1. Wheel guard not lowered 2. Damage to wheel guard safety switch 	<ol style="list-style-type: none"> 1. Lower wheel guard with wheel attached. 2. Replace wheel guard switch.
7	Excessive phase difference between the 2 measurement sensors	<ol style="list-style-type: none"> 1. Check for correct attachment of calibration weight. 2. Check machine connection; WBE 4430 probably not stable and vibrating excessively. 3. Check contact between measurement sensor and PCB. 4. Replace measurement sensor. 5. Replace PCB.
8	Inner measurement sensor not correctly connected, defective or open circuit in wire	<ol style="list-style-type: none"> 1. Check connection of left measurement sensor. 2. Replace measurement sensor.
9	Outer measurement sensor not correctly connected, defective or open circuit in wire	<ol style="list-style-type: none"> 1. Check connection of right measurement sensor. 2. Replace measurement sensor.
10	<ol style="list-style-type: none"> 1. Measurement sensor for position recognition defective 2. No motor operation 	<ol style="list-style-type: none"> 1. Check connection of light barrier PCB. 2. Check that the light barrier PCB is protected against light and provide a cover if necessary. 3. If the fault persists, check and if necessary replace the light barrier PCB. 4. Check the mains connection.
11	<ol style="list-style-type: none"> 1. Measurement sensor for phase recognition defective 2. No motor operation 	<ol style="list-style-type: none"> 1. Check connection of light barrier PCB. 2. Make sure the light barrier PCB is protected against light and provide a cover if necessary. 3. Check and if necessary replace the light barrier PCB. 4. Check the mains connection.
17	Weight outside setting range (weight required for balancing is more than 250 g)	<ol style="list-style-type: none"> 1. Check whether the wheel is correctly attached to the flange. 2. Determine the outer weight position (nevertheless), attach a 100 g weight and start a different measurement.
18	Wheel data not entered	Enter wheel data before performing measurement.
19	Input signal of right measurement sensor lower than that of left sensor	Interchange the connections of the two measurement sensors.

Faults	Causes	Remedy
20	1. Pedal pressed during measurement 2. Irregular rotational speed of motor 3. Wheel speed below minimum value	1. Do not press pedal whilst motor is in operation. 2. Make sure the WBE 4430 is not subjected to any impact during measurement. 3. Check mains voltage (probably too low).
21	The PCB has detected an excessively high wheel speed with the wheel guard open (shaft rotating at high speed although the machine has not been started): Power supply unit is deactivated	1. Switch off the WBE 4430 . 2. Lower the wheel guard, switch the WBE 4430 on again without moving the wheel. 3. If the error message persists, contact customer service.
22	Irregular measurement sensor signals	1. Check that the light barrier PCB is protected against light and provide a cover if necessary. 2. Check and if necessary replace the light barrier PCB. 3. Check and if necessary replace the display PCB.
29	ATTENTION: One vernier caliper/gauge arm not in rest position.	1. Set vernier caliper /gauge arm to rest position. 2. Repeat calibration of electronic vernier caliper/gauge arm.
30	Gauge arms deactivated.	Perform calibration prior to reactivation.
31	Pedal being pressed. Deactivation takes place.	1. Avoid pressing the pedal during measuring cycle; 2. Check correct functioning of the pedal micro switch.
32	Pedal has been pressed.	1. Avoid pressing the pedal during measuring cycle; 2. Check correct functioning of the pedal micro switch.
33	Incorrect operating system	Use a different PCB.
34	Restart the system.	
35	Draught calibration error.	Contact the After-sales assistance.
36	Draught calibration value out of tolerance.	Repeat the measuring cycle.
37	Printer incorrectly connected.	Check Printer connection.
38	Idioms text missing.	If the error occurs again, contact the after-sales assistance.
39	WINCE firmware version incorrect, for the language selected.	The language selected will be replaced by English.
40	Emergency stop.	Repeat the measuring cycle.
41	The width gauge must be calibrated.	Calibrate the width gauge.

12. Maintenance

12.1 Cleaning and servicing

! Before cleaning and servicing, switch off WBE 4430 and disconnect mains plug.

! Do not use any solvent-based cleaning agents. Use alcohol or similar cleaning agents for plastic parts.

The following work is essential to ensure proper operation and high performance of the WBE 4430:

Servicing	Weekly
Clean moving mechanical parts, treat with spray oil or kerosene and lubricate with engine oil or a suitable grease.	x

12.2 Calibration

 As part of service and upkeep (every six months), on flange replacement or in the event of measurement inaccuracies, it is advisable to calibrate the WBE 4430 in the following sequence:

1. Flange calibration.
2. Vernier caliper and gauge arm calibration.
3. WBE 4430 calibration.
4. Perform reference measurement.





12.2.1 Call-up of calibration menu

1. Call up the "Settings and service" menu.



2. Enter the password: <=> <=> <=> <=>.
- The calibration menu is displayed.



	Calibration with "Go" wheel
	Flange calibration
	Return to main page.
	Vernier caliper and gauge arm calibration

12.2.2 Flange calibration

 Follow the instructions shown on the monitor.

1. Fit the flange (refer to Section 5).

 Do not clamp the wheel, do not use any clamping tools.

2. Select flange calibration and confirm with <OK>.



- ⇒ Calibration is started.
3. Close the wheel guard.
 - ⇒ Measurement commences.
 - Flange calibration completed.
 - Unbalance set to "0".

12.2.3 Calibration of electronic vernier caliper/ gauge arm

 Follow the instructions shown on the monitor.

1. Select calibration of the slide caliper and of the angular width gauge and confirm using **<OK>**.



⇒ Calibration begins.

2. Move the slides with distance A and width B to standby position and press **<OK>**.

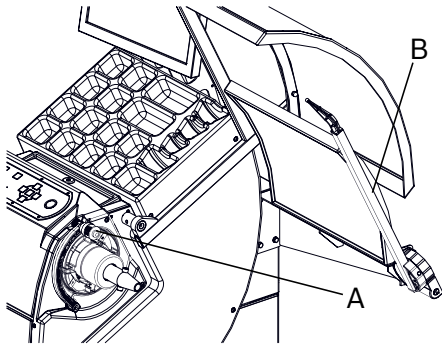

3. Move the reading cursor of distance 0 mm. Set the value read and press **<OK>**.
4. Move the cursor of distance A against the interior of the flange. Measure and set the value read and press **<OK>**.

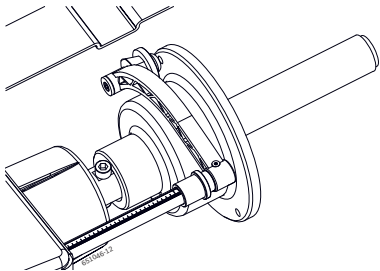

5. Keeping the distance A cursor in standby, move the cursor of width B width against the external part of the flange and press **<OK>**.

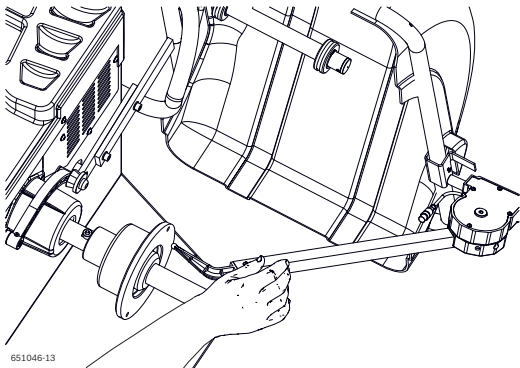

6. Assemble the width calibration pin on the external part of the flange. Move the width cursor against the end of the pin and press **<OK>**.

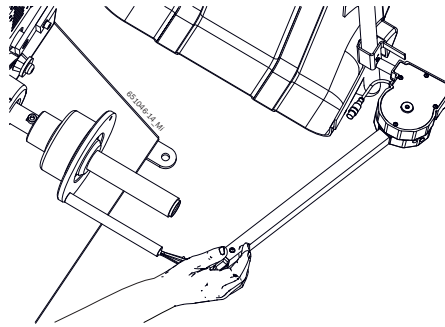

7. Remove the pin and assemble a 14" or 15" steel sample wheel using the relevant hold-down nut.

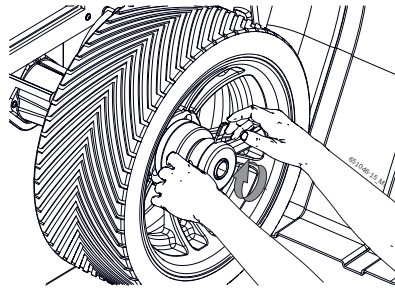

8. Set the wheel measurements and, with the distance reading cursor resting on the wheel itself, press **<OK>**.

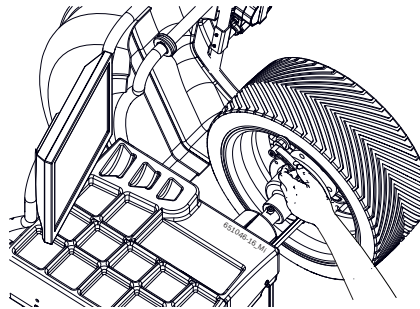

⇒ Procedure completed.

12.2.4 Calibration of WBE 4430

 Follow the instructions shown on the monitor.

1. Attach a motor vehicle wheel of medium size (e.g. width 5.5", diameter 14") and in very good condition to the flange.
2. Select WBE 4430 calibration and confirm with **<OK>**.



⇒ Calibration is started.

3. Enter the rim data and confirm with **<OK>**.
4. Press **<START>**.
⇒ Measurement commences.
5. Enter any balance weight between 40 g and 120 g and confirm with **<OK>**.
6. Attach a balance weight of the value entered to the inner side of the wheel.
7. Press **<START>**.
⇒ Measurement commences.
8. Turn the wheel until the balance weight is in the 12 o'clock position.
9. Remove the balance weight from the inner side of the wheel and attach it to the outer side (12 o'clock).
10. Press **<START>**.
⇒ Measurement commences.
11. Turn the wheel such that the weight is in the 6 o'clock position.
12. Press **<OK>**.

→ This completes calibration.

 The calibration made is permanently stored automatically.

12.2.5 Reference measurement

 Exact centering of the wheel is a basic prerequisite for this reference measurement and for all balancing operations.

 Sound and automatic start are active in the following description (refer to Section 8.3.3).

1. Attach a motor vehicle wheel of medium size (e. g. width 5.5", diameter 14") and in very good condition to the flange.
2. Enter the wheel data (refer to Section 8.2).
3. Close the wheel guard.
⇒ Measurement commences.
4. Create an artificial unbalance by attaching a test weight of e. g. 60 g to one of the two sides.
5. Close the wheel guard.
⇒ Measurement commences.
⇒ The WBE 4430 must display precisely this unbalance (value and position) on this side. The value indicated for the other side must not exceed 5 g.

 To check the position of the unbalance, turn the wheel until the position recommended for attachment of the balance weights is attained. The test weight attached must be vertically beneath the axis of rotation (6 o'clock position).

-  Calibration must be repeated in the following cases:
- Deviation from specified unbalance value (greater than 1 g on test weight side, more than 5 g on other side).
 - Deviation from specified unbalance position (test weight not between 5:30 and 6:30 position).

6. Remove the test weight.
7. Release the wheel and turn it through approx. 35°.
8. Re-attach the wheel.
9. Close the wheel guard.
⇒ Measurement commences.

→ On completion of this reference measurement, the display must not exceed a maximum unbalance of 10 g per side (15 g for particularly heavy wheels). This error may be caused by the rim centering tolerances. If this reference measurement indicates greater unbalance, the components used for centering the wheel must be checked for wear, play and contamination.

13. Decommissioning

13.1 Temporary shutdown

In the event of lengthy periods of non-use:

- Unplug the electrical connection.
- Unfasten the compressed air connection.

13.2 Change of location

- If the WBE 4430 is passed on, all the documentation included in the scope of delivery must be handed over together with the unit.
- The WBE 4430 is only ever to be transported in the original or equivalent packaging.
- Unplug the electrical connection.
- Heed the notes on initial commissioning.
- Unfasten the compressed air connection.
- Bolt the WBE 4430 back onto the pallet.

13.3 Disposal and scrapping

13.3.1 Substances hazardous to water



Oils and greases as well as refuse containing oil and grease (e.g. filters) represent a hazard to water.

1. Substances hazardous to water must not be allowed to enter the sewage system.
2. Substances hazardous to water must be disposed of in accordance with the applicable regulations.

13.3.2 WBE 4430 and accessories

1. Disconnect the WBE 4430 from the mains and detach the power cord.
2. Dismantle the WBE 4430 and sort out and dispose of the different materials in accordance with the applicable regulations.



The WBE 4430 is subject to the European directive 2002/96/EC (WEEE).

Dispose of used electrical and electronic devices, including cables, accessories and batteries, separately from household waste.

- Make use of the local return and collection systems for disposal.
- Proper disposal of the WBE 4430 prevents environmental pollution and possible health hazards.

14. Technical data

14.1 WBE 4430

Function	Specification
Balancing speed	218 U/min 50 Hz / 262 U/min 60 Hz
Resolution	1/5 g (0.05/0.15 oz)
Noise	< 70 dB
Energy consumption	0,7 kW
Power supply	115 V 1~ (60 Hz) / 115 V 1~ (50 Hz) 230 V 1~ (50 Hz) / 230 V 1~ (60 Hz)
Protection class	IP 22

14.2 Operating range

Function	min – max
Rim width	1"– 21"
Rim diameter	12"– 30"
Maximum wheel diameter	1200 mm
Maximum wheel weight	80 kg
Power supply	115 V 1~ (50 Hz)
Software version	6.21
Maximum settable diameter	6" - 40"
Maximum measurable diameter	12" - 30"
Power input	0,7 kw
Pneumatic supply	8 - 12 bar
Maximum width of wheel	510
Average cycle time	6 sec

14.3 Dimensions and weights

Function	Specification
WBE 4430 (H x W x D) max.	1680 x 1265 x 1380 mm
Net weight	164 kg

